

Model 1935/2935 Series

Single and Dual-Channel Optical Meters



User's Manual



Newport®
Experience | Solutions

EU Declaration of Conformity



We declare that the accompanying product, identified with the **CE** mark, complies with requirements of the Electromagnetic Compatibility Directive, 89/336/EEC and the Low Voltage Directive 73/23/EEC.

Model Number: 1935-C, 2935-C, 1935T-C, 2935T-C, 2935T-C-1

Year **CE mark affixed:** 2006

Type of Equipment: Electrical equipment for measurement, control and laboratory use.

Standards Applied:

Compliance was demonstrated to the following standards to the extent applicable:

BS EN61326-1: 1997+A1+A2 +A3 “Electrical equipment for measurement, control and laboratory use – EMC requirements”

This equipment meets the CISPR 11 Class A Group 1 radiated and conducted emission limits.

BS EN 61000-3-2:2001, Harmonic current emissions, Class A

BS EN 61000-3-3:2002, Voltage fluctuations and flicker

BS EN 61010-1:2001, 2nd Edition “Safety requirements for electrical equipment for measurement, control and laboratory use”



Alain Daniello
VP and GM of PPT Division.
Zone Industrielle
45340 Beaune-la-Rolande, France



Dan Dunahay
Director of Quality Systems
1791 Deere Avenue
Irvine, Ca. USA

Manual Updates

Dear Customer,

In an effort to keep the 1935/2935 Series Optical Meters optimized for your applications, Newport will on occasion update existing, and add new features to this instrument.

To utilize this new functionality will require an update to the instrument's firmware, which can be easily accomplished by the user, as described in this operator manual. As required, Newport will also generate a new version of this user manual, reflecting updates to the instrument.

Please check the Newport website (www.Newport.com) for newer versions of the firmware and the operator manual, which can be downloaded as a PDF file. Call your local Newport application specialist if you need support with locating or downloading these files.

Enjoy your new instrument!

Warranty

Newport Corporation warrants that this product will be free from defects in material and workmanship and will comply with Newport's published specifications at the time of sale for a period of one year from date of shipment. If found to be defective during the warranty period, the product will either be repaired or replaced at Newport's option.

To exercise this warranty, write or call your local Newport office or representative, or contact Newport headquarters in Irvine, California. You will be given prompt assistance and return instructions. Send the product, freight prepaid, to the indicated service facility. Repairs will be made and the instrument returned freight prepaid. Repaired products are warranted for the remainder of the original warranty period or 90 days, whichever first occurs.

Limitation of Warranty

The above warranties do not apply to products which have been repaired or modified without Newport's written approval, or products subjected to unusual physical, thermal or electrical stress, improper installation, misuse, abuse, accident or negligence in use, storage, transportation or handling. This warranty also does not apply to fuses, batteries, or damage from battery leakage.

THIS WARRANTY IS IN LIEU OF ALL OTHER WARRANTIES, EXPRESSED OR IMPLIED, INCLUDING ANY IMPLIED WARRANTY OF MERCHANTABILITY OR FITNESS FOR A PARTICULAR USE. NEWPORT CORPORATION SHALL NOT BE LIABLE FOR ANY INDIRECT, SPECIAL, OR CONSEQUENTIAL DAMAGES RESULTING FROM THE PURCHASE OR USE OF ITS PRODUCTS.

First printing 2006

© 2006 by Newport Corporation, Irvine, CA. All rights reserved. No part of this manual may be reproduced or copied without the prior written approval of Newport Corporation.

This manual has been provided for information only and product specifications are subject to change without notice. Any change will be reflected in future printings.

Newport Corporation
1791 Deere Avenue
Irvine, CA, 92606
USA

Part No. 44131-01, Rev. B

Firmware version 2.0.4

Confidentiality & Proprietary Rights

Reservation of Title:

The Newport programs and all materials furnished or produced in connection with them ("Related Materials") contain trade secrets of Newport and are for use only in the manner expressly permitted. Newport claims and reserves all rights and benefits afforded under law in the Programs provided by Newport Corporation.

Newport shall retain full ownership of Intellectual Property Rights in and to all development, process, align or assembly technologies developed and other derivative work that may be developed by Newport. Customer shall not challenge, or cause any third party to challenge the rights of Newport.

Preservation of Secrecy and Confidentiality and Restrictions to Access:

Customer shall protect the Newport Programs and Related Materials as trade secrets of Newport, and shall devote its best efforts to ensure that all its personnel protect the Newport Programs as trade secrets of Newport Corporation. Customer shall not at any time disclose Newport's trade secrets to any other person, firm, organization, or employee that does not need (consistent with Customer's right of use hereunder) to obtain access to the Newport Programs and Related Materials. These restrictions shall not apply to information (1) generally known to the public or obtainable from public sources; (2) readily apparent from the keyboard operations, visual display, or output reports of the Programs; 3) previously in the possession of Customer or subsequently developed or acquired without reliance on the Newport Programs; or (4) approved by Newport for release without restriction.

Service Information

This section contains information regarding factory service for the source. The user should not attempt any maintenance or service of the system or optional equipment beyond the procedures outlined in this manual. Any problem that cannot be resolved should be referred to Newport Corporation.

Copyright and Trademark Information

WINDOWS™ is a registered Trademark of Microsoft Corporation
LabVIEW is a registered Trademark of National Instruments INC.
Visual Basic is a registered Trademark of Microsoft Corporation.
Visual C++ is a registered Trademark of Microsoft Corporation.

Technical Support Contacts

North America & Asia

Newport Corporation Service Dept.

1791 Deere Ave. Irvine, CA 92606

Telephone: (949) 253-1694

Telephone: (800) 222-6440 x31694

Asia

Newport Opto-Electronics Technologies

253 Aidu Road, Bld #3, Flr 3, Sec C,
Shanghai 200131, China

Telephone: +86-21-5046 2300

Fax: +86-21-5046 2323

Europe

Newport/MICRO-CONTROLE S.A.

Zone Industrielle

45340 Beaune la Rolande, FRANCE

Telephone: (33) 02 38 40 51 56

Newport Corporation Calling Procedure

If there are any defects in material or workmanship or a failure to meet specifications, promptly notify Newport's Returns Department by calling 1-800-222-6440 or by visiting our website at www.newport.com/returns within the warranty period to obtain a **Return Material Authorization Number (RMA#)**. Return the product to Newport Corporation, freight prepaid, clearly marked with the RMA# and we will either repair or replace it at our discretion. Newport is not responsible for damage occurring in transit and is not obligated to accept products returned without an RMA#.

E-mail: rma.service@newport.com

When calling Newport Corporation, please provide the customer care representative with the following information:

- Your Contact Information
- Serial number or original order number
- Description of problem (i.e., hardware or software)

To help our Technical Support Representatives diagnose your problem, please note the following conditions:

- Is the system used for manufacturing or research and development?
- What was the state of the system right before the problem?
- Have you seen this problem before? If so, how often?
- Can the system continue to operate with this problem? Or is the system non-operational?
- Can you identify anything that was different before this problem occurred?

IMPORTANT NOTE

Before plugging the instrument into a PC via a USB communication port, please make sure that the USB Drivers are installed. Run Setup.exe from the Software CD that came with your product. The installation program will configure the PC with the 1935/2935 Series USB drivers.

Table of Contents

EU Declaration of Conformity.....	iii
Warranty.....	v
Technical Support Contacts	vii
Table of Contents.....	ix
List of Figures	xiii
List of Tables	xv
1 Safety Precautions	17
1.1 Definitions and Symbols	17
1.1.1 General Warning or Caution	17
1.1.2 Electric Shock.....	17
1.1.3 Protective Conductor Terminal	17
1.1.4 CSA Mark with “C” and “US” Indicators	18
1.1.5 European Union CE Mark	18
1.1.6 Alternating voltage symbol	18
1.1.7 On	18
1.1.8 Off.....	19
1.1.9 Fuses	19
1.1.10 Frame or Chassis	19
1.1.11 USB Connector Symbol	19
1.1.12 Waste Electrical and Electronic Equipment (WEEE)	20
1.2 Warnings and Cautions.....	20
1.2.1 General Warnings.....	20
1.2.2 General Cautions	21
1.3 Location of Warnings.....	22
1.3.1 Rear Panel.....	22
2 General Information	23
2.1 Introduction	23
2.2 Optical Meter Functionality	24
2.3 Model 1935-C.....	24
2.4 Model 2935-C.....	24
2.5 Model 1935T-C	24
2.6 Model 2935T-C	24
2.7 Calibration	25
2.8 Specifications	25
2.8.1 Physical Specifications:.....	25
2.8.2 Electrical Specifications	26
2.9 Unpacking and Handling.....	28
2.10 Inspection for Damage	29
2.11 Available Options and Accessories	29
2.12 Parts List.....	29
2.13 Choosing and Preparing a Suitable Work Surface	29
2.14 Electrical Requirements.....	30
2.15 Power Supplies	30

3	System Overview	31
3.1	Startup Procedure	31
3.2	Front Panel Layout	31
3.2.1	Front Panel Elements	32
3.2.2	Understanding the Main Screen	32
3.3	Rear Panel Layout	32
3.3.1	Elements That Vary by Model (on back panel)	32
3.3.2	Panel Layout	33
3.3.3	Changing Voltage Settings	36
3.4	Rack Mounting the 1935/2935 Series	37
4	System Operation	41
4.1	Front Panel Keys	41
4.1.1	Power Switch	41
4.1.2	Setup/Enter Key	42
4.1.3	Esc Key	43
4.1.4	Navigation and Selection Keys	43
	Channel Swapping	43
	Navigation	44
4.1.5	Soft Keys	44
4.1.6	Dedicated Keys	44
	Range	45
	Mode	46
	Hold	46
	Filter	47
	Lambda (λ) Key	48
	Set Zero Offset	48
4.2	Measurement Settings	48
4.2.1	Changing the Measurement Settings	49
	Wavelength Selection	49
	Range Selection	49
	Attenuator On/Off	49
	Analog and Digital Filter Selection	50
	Units Selection	50
	Mode Selection	50
	Number of Digits Setting	50
	Offset Field	50
4.2.2	Detector Information	50
4.3	Trigger Setup	51
4.3.1	Trigger Delay	51
4.3.2	Trigger Start	51
4.3.3	Trigger Stop	52
4.4	Wavelength Setting	52
4.5	Display Color	53
4.6	USB Address and RS232 Parameters	54
4.7	Statistics	54
4.7.1	Graph	55

4.8	Math Functions.....	55
4.9	Display Modes.....	56
4.9.1	Numeric Display.....	57
4.9.2	Analog Bar.....	57
4.9.3	Analog Needle.....	58
4.9.4	Vertical Chart.....	59
4.10	Cooled Detectors Operation.....	60
4.11	Firmware Upgrade Procedure.....	60
5	Performing Basic Measurements	61
5.1	Introduction.....	61
5.2	Measurement Modes and Units.....	61
5.3	CW Measurements (with 918D or 818P Detectors).....	62
5.4	Peak-to-Peak Power Measurements (918D Detectors).....	63
5.5	Power Ratio and Power Reference measurements.....	64
5.6	Pulse Energy Measurements (818E Detectors).....	65
5.7	Signal Integration Measurements (918D or 818P Detectors).....	65
5.8	Measuring Laser Pulse Energy with an 818P Thermopile Detector (Single Shot).....	66
5.9	Frequency Measurements (918D or 818E Detectors).....	67
5.10	RMS Measurements.....	68
6	Software Application	69
6.1	Overview.....	69
6.2	Connection.....	69
6.3	General Usage.....	70
6.4	Menu Structure.....	70
7	Computer Interfacing	71
7.1	General Guidelines.....	71
7.2	Computer Interface Terminology.....	71
7.2.1	<...> Delimiting Punctuation.....	71
7.2.2	<CR> Carriage Return.....	71
7.2.3	<LF> Line Feed.....	71
7.2.4	(;) Semicolons.....	71
7.2.5	<number> Numerical Types.....	72
7.2.6	<string> String Types.....	72
7.2.7	Command Termination.....	72
7.2.8	Response Termination.....	72
7.3	Entering Remote Computer Interface Mode.....	72
7.4	RS-232C Communication.....	72
7.4.1	Setting Echo Mode From the Keypad.....	73
7.4.2	Setting Echo Mode via Remote Interface.....	73
7.4.3	Setting the USB Address.....	73
7.5	USB Communication.....	73

8	Communication Command Reference	75
8.1	Model 1935/2935 Series Remote Interface Commands	75
8.2	Command Overview	75
8.2.1	Activate a Specific Channel	76
8.3	Command Description	76
8.3.1	Command Glossary	76
8.3.2	Display Commands	78
8.3.3	Power Meter Commands	79
8.3.4	TEC Commands (1935T-C/2935T-C only)	104
9	Principles Of Operation	105
9.1	Introduction	105
9.2	Analog Signal Flow	105
9.3	Digitized Signal Flow	106
9.4	Typical Detector Signals	107
9.5	Thermopile Detector Signals	108
9.6	Pulse Energy Detector Signals	108
9.7	Peak-to-Peak (Photodiode) Detector Signals	109
9.8	Integration of Detector Signals	110
9.9	Analog Output	111
9.10	Measurement Considerations	112
9.10.1	Detector Calibration and Accuracy	112
9.10.2	Quantum Detector Temperature Effects	112
9.10.3	Thermopile Detector Temperature Effects	113
9.10.4	Energy Detector Temperature Effects	113
9.10.5	Ambient and Stray Light	113
9.10.6	Signal Filtering	114
9.11	Common Measurement Errors	115
10	Maintenance and Service	117
10.1	Enclosure Cleaning	117
10.2	Fuse Replacement	117
10.3	Obtaining Service	118
10.4	Service Form	119
11	Appendix A – Syntax and Definitions	121
11.1	Definition of <string>	121
11.2	Definition of <number>	122
12	Appendix B – Error Messages	125
12.1	Introduction	125
12.2	Command Errors	125
12.3	Execution Errors	126
12.4	Device Errors	127
13	Appendix C - Legacy Commands Reference	129

14	Appendix D – Sample Programs	131
14.1	Programming Samples.....	131
14.2	LabVIEW	131
14.3	Microsoft® Visual Basic	131
14.4	Microsoft Visual C++	131
14.5	Microsoft .NET.....	131
15	Appendix E – Disassembly Instructions	133
15.1	Disassembly instructions	133

List of Figures

Figure 1	General Warning or Caution Symbol.....	17
Figure 2	Electrical Shock Symbol.....	17
Figure 3	Protective Conductor Terminal Symbol	17
Figure 4	CSA mark with “C” and “US” Indicators	18
Figure 5	CE Mark.....	18
Figure 6	Alternating Voltage Symbol	18
Figure 7	On Symbol	18
Figure 8	Off Symbol.....	19
Figure 9	Fuse Symbol.....	19
Figure 10	Frame or Chassis Terminal Symbol.....	19
Figure 11	USB connector Symbol.....	19
Figure 12	WEEE Directive Symbol	20
Figure 13	AC Receptacle Warning Label.....	21
Figure 14	Locations of warnings on the rear panel	22
Figure 15	Front Panel Layout.....	31
Figure 16	1935-C Rear Panel Layout.....	33
Figure 17	2935-C Rear Panel Layout.....	34
Figure 18	1935T-C Rear Panel Layout	34
Figure 19	2935T-C Rear Panel Layout	35
Figure 20	2935T-C-1 Rear Panel Layout.....	35
Figure 21	PM1 –RACK mounting kit	38
Figure 22	PM2 –RACK mounting kit	39
Figure 23	Mounting details for the PM1 –RACK mounting kit	40
Figure 24	Front Panel keys.....	41
Figure 25	Power Switch	41
Figure 26	Navigation/Selection and Setup/Enter keys.....	42
Figure 27	Main screen	42
Figure 28	Measurement Settings screen.....	43
Figure 29	Channel A primary	43
Figure 30	Channel B primary	43
Figure 31	Soft keys.....	44
Figure 32	Dedicated keys	44
Figure 33	Manual Range mode	45
Figure 34	Auto Range mode.....	45

Figure 35	This screen is displayed after pressing the Config soft key	45
Figure 36	Mode selection screen	46
Figure 37	Measurement is on hold	46
Figure 38	Measurement is running	46
Figure 39	Filter selection screen	47
Figure 40	Filter configuration screen	47
Figure 41	Digital Filter editing	47
Figure 42	Wavelengths screen	48
Figure 43	Zero Selection	48
Figure 44	Measurement Settings screen	48
Figure 45	Accessing the Trigger Setup screen	51
Figure 46	Trigger Delay waveforms	51
Figure 47	Predefined color schemes	53
Figure 48	Setup screen	53
Figure 49	System Settings screen	53
Figure 50	Statistics screen	54
Figure 51	Graph screen	55
Figure 52	Math field	55
Figure 53	Math configuration screen	56
Figure 54	Mode selection screen	56
Figure 55	The Numeric display	57
Figure 56	Analog Bar	57
Figure 57	Auto Zoom	58
Figure 58	Analog Needle display	58
Figure 59	Vertical chart with 10 measurements per line	59
Figure 60	Vertical chart with 1 measurement per line	59
Figure 61	Measuring Laser Pulse Energy via a Thermopile in CW Integrate Mode	66
Figure 62	Application front panel	69
Figure 63	Application Advanced Options (Configuration Tab)	70
Figure 64	RS-232 9 Pin to 9Pin Cable Connections. Cable terminators (RS-232)	73
Figure 65	Model 1935/2935 Series Analog Signal Flow Diagram	105
Figure 66	Thermopile Signals exhibit 1 to 10 second time constants	108
Figure 67	Typical Newport Energy Detector Signal Waveform	109
Figure 68	Negative Baseline Voltage	109
Figure 69	Time Varying Signal Measurements	110
Figure 70	Integrated Energy Via a Trapezoid Approximation	110
Figure 71	Measuring Laser Pulse Energy with a Thermopile	111
Figure 72	Fuse Replacement	117
Figure 73	Disassembled 1935/2935 model	134

List of Tables

Table 1	Available Measurement Modes and Valid Units.	62
Table 2	Root level Commands/Queries Summary	76
Table 3	Tree Level Commands/Queries Summary	78
Table 4	Analog Signal Flow Paths.....	106
Table 5	Analog Output Range Table.	111
Table 6	Common Measurement Errors	115
Table 7	Legacy Commands Reference.....	130

This page is intentionally left blank

1 Safety Precautions

1.1 Definitions and Symbols

The following terms and symbols are used in this documentation and also appear on the Models 1935/2935 Series Optical Power Meters where safety-related issues occur.

1.1.1 General Warning or Caution



Figure 1 General Warning or Caution Symbol

The Exclamation Symbol in the figure above appears in Warning and Caution tables throughout this document. This symbol designates an area where personal injury or damage to the equipment is possible.

1.1.2 Electric Shock



Figure 2 Electrical Shock Symbol

The Electrical Shock Symbol in the figure above appears throughout this manual. This symbol indicates a hazard arising from dangerous voltage. Any mishandling could result in irreparable damage to the equipment, and personal injury or death.

1.1.3 Protective Conductor Terminal



Figure 3 Protective Conductor Terminal Symbol

The protective conductor terminal symbol in the above figure identifies the location of the bonding terminal, which is bonded to conductive accessible parts of the enclosure for safety purposes.

1.1.4 CSA Mark with “C” and “US” Indicators



Figure 4 CSA mark with “C” and “US” Indicators

The presence of the CSA mark with “C” and “US” indicates that it has been designed, tested and certified as complying with all applicable U.S. and Canadian safety standards.

1.1.5 European Union CE Mark



Figure 5 CE Mark

The presence of the CE Mark on Newport Corporation equipment means that it has been designed, tested and certified as complying with all applicable European Union (CE) regulations and recommendations.

1.1.6 Alternating voltage symbol



Figure 6 Alternating Voltage Symbol

This international symbol implies an alternating voltage or current.

1.1.7 On



Figure 7 On Symbol

The On Symbol in the figure above represents a power switch position on the 1935/2935 Series Optical Power Meters. This symbol represents a Power On condition.

1.1.8 Off

Figure 8 Off Symbol

The Off Symbol in the figure above represents a power switch position on the 1935/2935 Series Optical Power Meters. This symbol represents a Power Off condition.

1.1.9 Fuses

Figure 9 Fuse Symbol

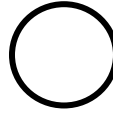
The fuse symbol in the figure above identifies the fuse location on the Models 1935/2935 Series Optical Power Meters.

1.1.10 Frame or Chassis

Figure 10 Frame or Chassis Terminal Symbol

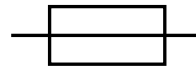
The symbol in the figure above appears on the 1935/2935 Series Optical Power Meters. This symbol identifies the frame or chassis terminal

1.1.11 USB Connector Symbol

Figure 11 USB connector Symbol

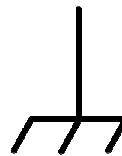
The USB connector symbol in the above figure identifies the location of the USB communications connector.

1.1.12 Waste Electrical and Electronic Equipment (WEEE)



Figure 12 WEEE Directive Symbol

This symbol on the product or on its packaging indicates that this product must not be disposed of with regular waste. Instead, it is the user responsibility to dispose of waste equipment according to the local laws. The separate collection and recycling of the waste equipment at the time of disposal will help to conserve natural resources and ensure that it is recycled in a manner that protects human health and the environment. For information about where the user can drop off the waste equipment for recycling, please contact your local Newport Corporation representative. See Section 15 for instructions on how to disassemble the equipment for recycling purposes.

1.2 Warnings and Cautions

The following are definitions of the Warnings, Cautions and Notes that are used throughout this manual to call your attention to important information regarding your safety, the safety and preservation of your equipment or an important tip.

	<p>WARNING</p> <p>Situation has the potential to cause bodily harm or death.</p>
--	---

	<p>CAUTION</p> <p>Situation has the potential to cause damage to property or equipment.</p>
--	--

NOTE

Additional information the user or operator should consider.

1.2.1 General Warnings

Observe these general warnings when operating or servicing this equipment:

- Heed all warnings on the unit and in the operating instructions.
- Do not use this equipment in or near water.

- This equipment is grounded through the grounding conductor of the power cord.
- Route power cords and other cables so they are not likely to be damaged.
- Disconnect power before cleaning the equipment. Do not use liquid or aerosol cleaners; use only a damp lint-free cloth.
- Lockout all electrical power sources before servicing the equipment.
- To avoid fire hazard, use only the specified fuse(s) with the correct type number, voltage and current ratings as referenced in the appropriate locations in the service instructions or on the equipment. Only qualified service personnel should replace fuses.
- To avoid explosion, do not operate this equipment in an explosive atmosphere.
- Qualified service personnel should perform safety checks after any service.

1.2.2 General Cautions

Observe these cautions when operating or servicing this equipment:

- Before applying power, carefully read the warning label placed over the AC power input receptacle in back of the instrument.

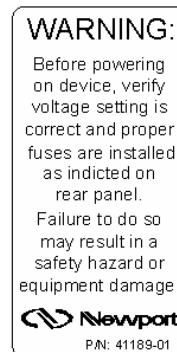

Figure 13 AC Receptacle Warning Label

- If this equipment is used in a manner not specified in this manual, the protection provided by this equipment may be impaired.
- To prevent damage to equipment when replacing fuses, locate and correct the problem that caused the fuse to blow before re-applying power.
- Do not block ventilation openings.
- Do not position this product in such a manner that would make it difficult to disconnect the power cord.
- Use only the specified replacement parts.
- Follow precautions for static sensitive devices when handling this equipment.
- This product should only be powered as described in the manual.

- There are no user-serviceable parts inside the 1935/2935 Series Optical Power Meters.
- To prevent damage to the equipment, read the instructions in the equipment manual for proper input voltage.
- Adhere to good laser safety practices when using this equipment.

1.3 Location of Warnings

1.3.1 Rear Panel

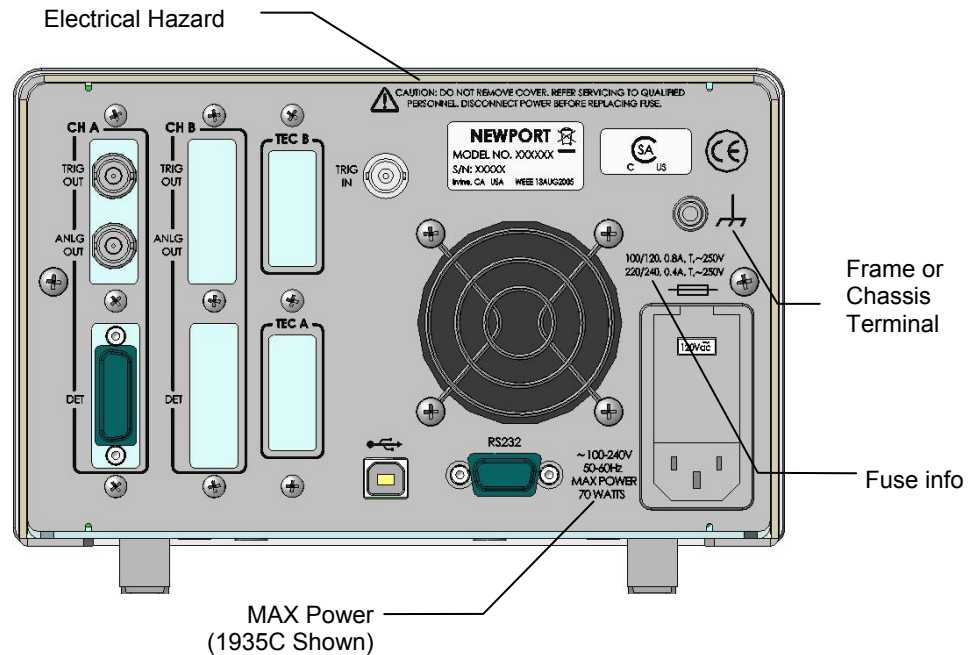

Figure 14 Locations of warnings on the rear panel

2 General Information

2.1 Introduction

The 1935/2935 Series Optical Meters are designed to provide a powerful combination of features to measure optical power and energy of near-monochromatic or monochromatic sources. Use of the extensive measurement modes and features have been simplified with an intuitive menu driven structure that provides quick access to all modes, features and settings. Some of the prominent specifications and features that will simplify your calibrated measurement applications are in the following:

- Compatibility with Photodiode, Thermopile and Pyroelectric detectors. (Low-Power (Semiconductor) Family, High-Power (Thermopile) Family, Energy (Pyroelectric) Family, InGaAs Cooled, Photometric, PMT, GaN, PbS, PbSe, and HgCdZnTe)
- Up to 20 kHz repetition rates for photodiode detectors and up to 10 kHz repetition rates for pyroelectric detectors with signal sampling rates of up to 250 kHz.
- Multiple measurement modes for power and energy measurements: Single, Continuous, Integrated, Peak-to-Peak and Frequency.
- Software suite, including LabVIEW drivers, .NET programming capability and high-speed data transfer utility.
- 250,000 of internal data point storage and external USB flash-memory compatibility.
- Triggering features to synchronize measurements with external events.
- Built-in temperature controller (1935T-C, 2935T-C and 2935T-C-1 only) for cooled detectors (e.g. 918D-IG-C1).
- USB and RS-232 Interfaces
- Rack Mountable in Single or Dual Set Configurations

The full color TFT 5.6" LCD renders excellent visibility both with the naked eye and laser goggles for single screen rendering of plotted and enumerate results. Measurements can be displayed in W, Joules, Amps, Volts, Hertz, dBm, dB or relative units, either directly or as relative ratio measurements from present or stored values. Statistical capabilities include the computation of Min, Max, Max-Min, Mean and Standard Deviation. Additional features such as digital and analog filtering, and data storage of up to 250,000 readings per channel are also offered.

Newport's experience with calibration, together with N.I.S.T. calibration traceability and high precision optical power meters provide users with accurate measurements and exceptional inter-instrument correlation. In R&D, QA/QC, and manufacturing environments, the 1935/2935 Series power meters enable users to benefit from high correlation between multiple locations at a price-to-performance ratio second to none. Among all the other practical tools provided, remote controlling with a computer and synchronization to other instruments are simplified with the inclusion of LabVIEW drivers, tools to develop in the .NET environment and a high-speed software utility that fully utilized the optical meter's ability to sample at 250 kHz and transfer data via USB interface at 8 Mbps.

2.2 Optical Meter Functionality

Optical meters in the 1935/2935 Series product line are designed to provide continuous wave (CW) and pulsed source measurements that support the testing and production needs of free space beams and fiber optics based sources. These optical meters come in one or two channel configurations and with cooled detector controllers. They require detectors having a 15-pin D-Sub type Male connector.

2.3 Model 1935-C

The model 1935-C optical meter is a 1-channel input optical meter compatible with all Newport detectors having a 15-pin D-sub type connector. All product features and capabilities described herein are included in this model, except a second detector channel or built in detector cooler controller.

2.4 Model 2935-C

The model 2935-C optical meter is a 2-channel input optical meter compatible with all Newport detectors having a 15-pin D-sub type connectors. All product features and capabilities described herein are included in this model, except a built in detector cooler controller.

2.5 Model 1935T-C

The model 1935T-C optical meter is a 1-channel input optical meter with a built in detector cooler controller compatible with all cooled detectors and detectors having a 15-pin D-sub type connector offered by Newport Corporation. All product features and capabilities described herein are included in this model, except a second detector channel.

2.6 Model 2935T-C

The model 2935T-C optical meter is a 2-channel input optical meter with two (2) built in detector cooler controllers compatible with cooled detectors and detectors having a 15-pin D-sub type connector offered by Newport Corporation. All product features and capabilities described herein are included in this model.

2.7 Calibration

Calibration of the power meter is done at the factory by defining a slope and offset, for all ranges as determined for each detector type.

Newport recommends annual factory re-calibration to ensure the continued accuracy of power meter measurements.

Please refer to the “Maintenance and Troubleshooting” section for contact information for re-calibration of your power meter.

2.8 Specifications

2.8.1 Physical Specifications:

Dimensions:	5.25 x 12.11 x 8.50 in (133 x 308 x 216 mm)
Weight:	max. 12.4 lb.
Enclosure:	Metal case, painted
Connectors:	Optical Detector 15-Pin D-Sub, TEC 15-Pin D-Sub (optional), BNC Analog Output, Trigger Output, Trigger Input, 9 Pin D-Sub RS-232, USB Host, USB Device
Power:	100/120/220/240VAC \pm 10%, 50/60 Hz, 70 Watts
Display:	Graphical LCD $\frac{1}{4}$ VGA, 5.7 in diagonal
Display Update Rate:	\geq 20 Hz
Operating Environment:	5°C to 40°C; < 70% RH non-condensing
Storage Environment:	-20°C to 60°C; < 90% RH non-condensing
Altitude	< 3000m
Installation Category	II
Pollution Degree	2
Use Location	Indoor use only

2.8.2 Electrical Specifications

DC Current Measurement (Low-Power, Semiconductor Photodiode)

Signal Range ^{1,2}	0	1	2	3	4	5
Full-Scale Current	250 nA	2.50 μ A	25.0 μ A	250 μ A	2.50 mA	12.5 mA
Resolution	7.63 pA	76.3 pA	763 pA	7.63 nA	76.3 nA	381 nA
Bandwidth ⁸ (Unfiltered)	480 Hz	480 Hz	4 kHz	43 kHz	170 kHz	140 kHz
Accuracy (Filtered)	0.2%	0.2%	0.2%	0.2%	0.2%	0.2%
Accuracy (Maximum Measurement Rate=10kHz)	1.0%	1.0%	1.0%	1.0%	1.0%	1.0%
Signal to Noise Ratio ¹	100 dB	100 dB	100 dB	100 dB	100 dB	100 dB
Frequency Measurement (Square Wave Signal) ⁷	0.5 Hz – 1kHz	0.5 Hz – 2 kHz	0.5 Hz – 8 kHz	0.5 Hz – 80 kHz	0.5 Hz – 200 kHz	0.5 Hz – 200 kHz
Frequency Measurement (Sine Wave Signal) ⁷	20 Hz – 1 kHz	20 Hz – 2 kHz	20 Hz – 8 kHz	20 Hz – 80 kHz	20 Hz – 200 kHz	20 Hz – 200 kHz
Frequency Measurement Accuracy ⁷	1.0%	1.0%	1.0%	1.0%	1.0%	1.0%

Peak-Peak Current Measurement (Low-Power, Semiconductor Photodiode)

Signal Range ^{2,3}	0	1	2	3	4	5
Full-Scale Current	250 nA	2.50 μ A	25.0 μ A	250 μ A	2.50 mA	12.5 mA
Resolution	7.63 pA	76.3 pA	763 pA	7.63 nA	76.3 nA	381 nA
Accuracy	1.0%	1.0%	1.0%	1.0%	1.0%	1.0%
Bandwidth ⁸	480 Hz	480 Hz	4 kHz	43 kHz	170 kHz	140 kHz
Maximum Pulse Repetition Rate ⁴	480 Hz	480 Hz	4 kHz	20 kHz	20 kHz	20 kHz
Frequency Measurement ⁷	20 Hz – 1kHz	20 Hz – 1 kHz	20 Hz – 8 kHz	20 Hz – 80 kHz	20 Hz – 160 kHz	20 Hz – 130 kHz
Frequency Measurement Accuracy ⁷	1.0%	1.0%	1.0%	1.0%	1.0%	1.0%

D.C. Voltage Measurement (Thermopile)

Signal Range ^{2,3}	0	1	2	3	4	5
Full-Scale Voltage	2.5mV	25.0 mV	250 mV	2.50 V	25.0 V	130 V
Resolution	76.3 nV	763 nV	7.63 μ V	76.3 μ V	763 μ V	3.96 mV
Accuracy (Filtered) ¹	0.3%	0.3%	0.3%	0.3%	0.3%	0.3%
Accuracy (Maximum Measurement Rate=10kHz)	1.0%	1.0%	1.0%	1.0%	1.0%	1.0%
Frequency Measurement (Square Wave Signal) ⁷	130 Hz – 200 kHz	20 Hz – 220 kHz	0.5 Hz – 220 kHz	0.5 Hz – 250 kHz	0.5 Hz – 220 kHz	0.5 Hz – 200 kHz
Frequency Measurement (Sine Wave Signal) ⁷	130 Hz – 200 kHz	20 Hz – 220 kHz	20 Hz – 220 kHz	20 Hz – 220 kHz	20 Hz – 220 kHz	20 Hz – 200 kHz
Frequency Measurement Accuracy ⁷	1.0%	1.0%	1.0%	1.0%	1.0%	1.0%
Bandwidth ⁸	640 kHz	1600 kHz	1600 kHz	1900 kHz	640 kHz	1900 kHz
Signal to Noise Ratio ¹	80dB	90dB	100dB	100dB	100dB	100dB

Pulse Voltage Measurement (Energy, Pyroelectric)

Signal Range ^{2,3}	0	1	2	3	4	5
Full-Scale Current	2.5mV	25.0 mV	250 mV	2.50 V	25.0 V	130 V
Resolution	76.3 nV	763 nV	7.63 μ V	76.3 μ V	763 μ V	3.96 mV
Accuracy	1.0%	1.0%	1.0%	1.0%	1.0%	1.0%
Frequency Measurement (Pulsed Signal) ⁷	130 Hz – 200 kHz	20 Hz – 220 kHz	0.5 Hz – 220 kHz	0.5 Hz – 250 kHz	0.5 Hz – 220 kHz	0.5 Hz – 200 kHz
Frequency Measurement Accuracy ⁷	1.0%	1.0%	1.0%	1.0%	1.0%	1.0%
Bandwidth ⁸	640 kHz	1600 kHz	1600 kHz	1900 kHz	640 kHz	1900 kHz
Maximum Pulse Repetition Rate ⁵	10 kHz	10 kHz	10 kHz	10 kHz	10 kHz	10 kHz

RMS Measurement

Maximum Pulse Repetition Rate	10 kHz
Accuracy	1.0 %

Analog Output

Output Range	0	1	2	3
Full Scale Voltage (Load > 100 k Ω)	1 V	2 V	5 V	10 V
Full Scale Voltage (Load = 50 Ω)	0.5 V	1 V	2.5 V	-
Accuracy	1.0 %	1.0 %	1.0 %	1.0 %
Linearity	0.3%	0.3%	0.3%	0.3%

Trigger Level

Programmable Level	0...100 % Full Scale
Resolution	0.39 % Full Scale

TEC Controller

TEC Maximum Current	1.5 A
TEC Maximum Compliance Voltage	1.5 V
Available Output Power	2.25W
Temperature Sensor Type	Thermistor, 10k Ω @ 25 °C
Accuracy	1.0 %
Sensor Bias	100 μ A
Temperature Range ⁶	-20 °C ... 70 °C

¹ With 5Hz filter on.

² Listed signal ranges specify meter capability. Available signal ranges are detector dependent.

³ Maximum measurable signal is detector dependent.

⁴ While the maximum repetition range may equal the bandwidth, it really depends on the signal duty-cycle or the signal shape.

⁵ The Maximum Repetition Rate refers to the meter pulse-by-pulse measuring capability. Due to its high bandwidth, the 1935/2935 can take in signals with higher repetitive rates and outputs them undistorted at the Analog Output.

⁶ The Temperature Range is detector dependent.

⁷ The Frequency Measurement min/max values are signal shape dependent. The specified frequency measurement range and accuracy are defined for an amplitude of half full scale.

⁸ The instrument bandwidth is determined by the detector used. Please refer to Newport Corporation's complete offering on detector type. The specified bandwidth is measured from the instrument input (detector) to the Analog Output BNC.

2.9 Unpacking and Handling

It is recommended that the Models 1935/2935 Series Optical Power Meters be unpacked in a lab environment or work site. Unpack the system carefully; small parts and cables are included with the instrument. Inspect the box carefully for loose parts before disposing of the packaging. You are urged to save the packaging material in case you need to ship your equipment in the future.

2.10 Inspection for Damage

The Models 1935/2935 Series Optical Power Meters are carefully packaged at the factory to minimize the possibility of damage during shipping. Inspect the box for external signs of damage or mishandling. Inspect the contents for damage. If there is visible damage to the instrument upon receipt, inform the shipping company and Newport Corporation immediately.



WARNING

Do not attempt to operate this equipment if there is evidence of shipping damage or you suspect the unit is damaged. Damaged equipment may present additional hazards to you. Contact Newport technical support for advice before attempting to plug in and operate damaged equipment.

2.11 Available Options and Accessories

Newport Corporation also supplies temperature controlled mounts, lenses, and other accessories. Please consult with your representative for additional information.

2.12 Parts List

The following is a list of parts included with the 1935/2935 Series Optical Power Meters:

1. User's Manual (Hardcopy)
2. Software Drivers and Utilities (CD)
3. Power cord
4. Two fuses

If you are missing any hardware or have questions about the hardware you have received, please contact Newport Corporation.

2.13 Choosing and Preparing a Suitable Work Surface

The Models 1935/2935 Series Optical Power Meters may be placed on any reasonably firm table or bench during operation. The front legs of the unit can be pulled out to tilt the unit at an angle, if desired.

Provide adequate distance between the 1935/2935 Series Optical Power Meters and adjacent walls for ventilation purposes. Approximately 2-inch spacing for all surfaces is adequate.

2.14 Electrical Requirements

Before attempting to power up the unit for the first time, the following precautions must be followed:



WARNING

To avoid electric shock, connect the instrument to properly earth-grounded, 3-prong receptacles only. Failure to observe this precaution can result in severe injury.

- Have a qualified electrician verify the wall socket that will be used is properly polarized and properly grounded.
- Set the mains selector tumbler to the voltage that matches the power outlet AC voltage.
- Verify the correct rated fuses are installed according to the fuse marking on the rear panel.

2.15 Power Supplies

AC power is supplied through the rear panel input power connector that provides in-line transient protection and RF filtering. The input power connector contains the fuses and the switch to select series or parallel connection of the transformer primaries for operation at 100VAC, 120VAC, 220VAC or 240VAC. The product is shipped with the setting on 110V. Please make sure you select the right setting according to your AC voltage level. Also, please make sure you insert the right fuses. The product is shipped with a spare of fuses for the 220VAC/240VAC settings.



CAUTION

Permanent damage will occur to the power meter if the input power connector settings are at either 100 or 120VAC and applied power is above 180VAC RMS

3 System Overview

3.1 Startup Procedure



WARNING

To avoid electrical shock hazard, connect the instrument to properly earth-grounded, 3-prong receptacles only. Failure to observe this precaution can result in severe injury.

Provided that the power meter has been installed in an appropriate environment and its power cord is connected to a working electrical outlet, power-up the power meter by pressing the power button on the lower left corner of the front panel.

For precise accuracy, 1935/2935 Series power meters should be allowed to warm up for one hour before being used for measurements.

3.2 Front Panel Layout

The front panel layout is the same for both the 1935 and 2935 products.

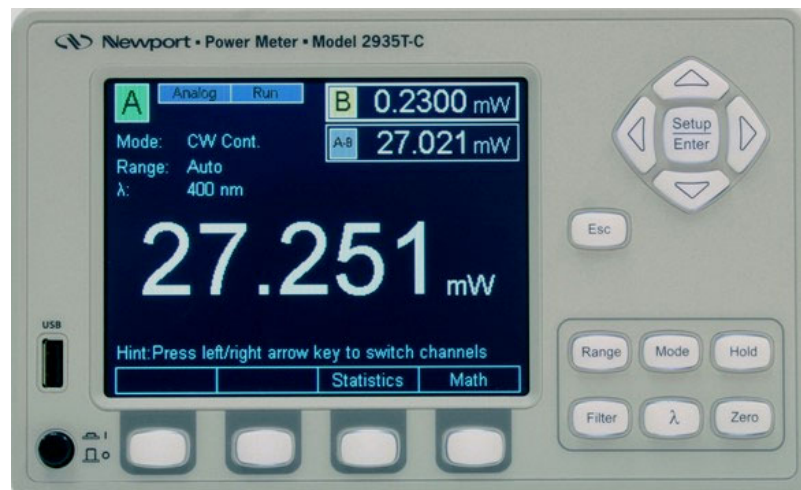

Figure 15 Front Panel Layout

3.2.1 Front Panel Elements

On the front panel of the 1935/2935 Series there are the following elements:

- A faceplate with an active color liquid crystal display
- USB A connector
- Power switch
- Menu/Enter, and Esc keys
- Rubberized horizontal (left/right) and vertical (up/down) arrow keys
- Four rubberized blank keys below the display (referred to as “soft keys” later in the manual, as their function depends on the text on the screen above the key.)
- Six rubberized buttons with dedicated functions – Range, Mode, Hold, Filter, Lambda (λ), Zero.

3.2.2 Understanding the Main Screen

The main screen is displayed after startup (Figure 15). The middle portion of the main screen is a real-time display of power measured in last used units, and the lower half of the main screen is a row of four labels for actions that the keys below them will activate. The top of this screen has the channel settings for the focus channel and a smaller reading for the non-focus channel (B in the figure).

When an annunciator label is visible, its function is enabled. If the annunciator appears on the display as an unlabeled key, the function it represents is currently disabled. Annunciators loosely correspond to keypad keys, which are used either alone or in combination with the navigation and selection keys to control annunciator functions.

3.3 Rear Panel Layout

3.3.1 Elements That Vary by Model (on back panel)

Single-channel power meters have the processing electronics installed on CH A, while dual-channel power meters have both CH A and CH B installed.

Input Connectors

The input connectors are on the rear panel. 1935-C and 2935-C power meter models support input from external detectors through DB15 detector connectors. Input channels on dual-channel power meters are labeled “CH A” and “CH B”.

A Trigger input offers the possibility of synchronizing the power meter measurements with external events.

The optional TEC input connects the power meter to a TEC element, which is used to cool down the detector.

Output Connectors

Power meters in the 1935/2935-C series support one analog output for each channel. Analog output enables direct monitoring of a detector through an oscilloscope or voltmeter.

On the rear panel there are also trigger outputs, one for each channel. The user can use these outputs to synchronize external equipment with events related to the power meter measurements.

3.3.2 Panel Layout

The rear panel is a brushed aluminum plate with input and output connectors for the following cable types (0):

- 15-Pin D-Sub Optical Detector Input, Channel A (1935-C/2935-C)
- BNC Analog Output, Channel A (1935-C/2935-C)
- BNC Trigger Output, Channel A (1935-C/2935-C)
- 15-Pin D-Sub Optical Detector Input, Channel B (2935-C)
- BNC Analog Output, Channel B (2935-C)
- BNC Trigger Output, Channel B (2935-C)
- 9-Pin D-Sub Thermo-Electric Cooler, Channel A (1935T-C),
- 9-Pin D-Sub Thermo-Electric Cooler, Channel B (2935T-C),
- BNC Trigger Input
- USB (Universal Serial Bus) Device
- 9-Pin D-Sub RS-232

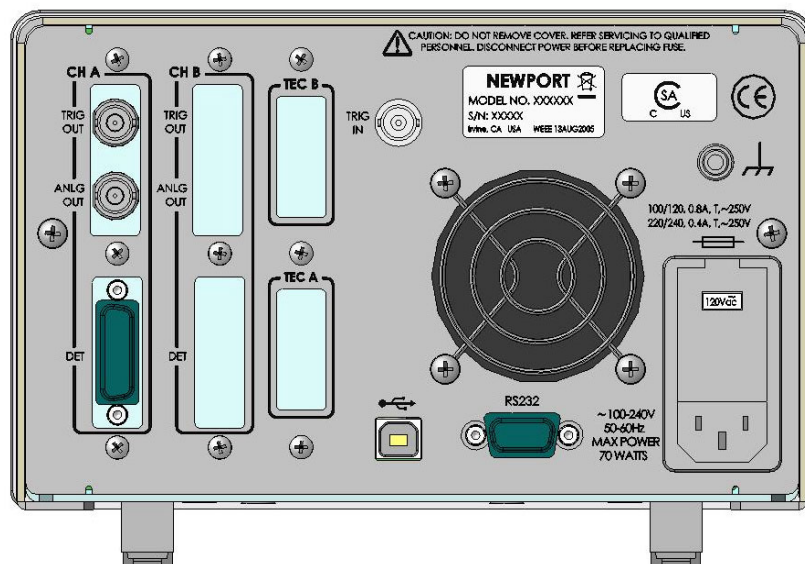

Figure 16 1935-C Rear Panel Layout

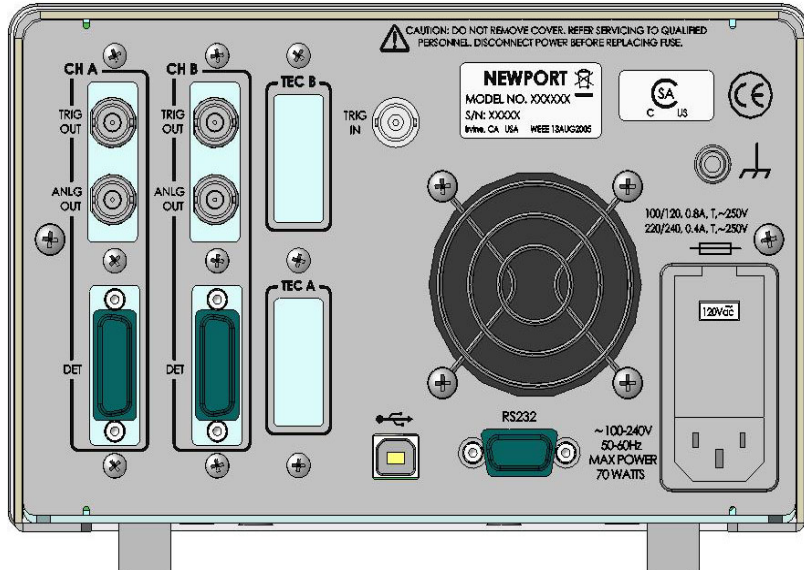

Figure 17 2935-C Rear Panel Layout

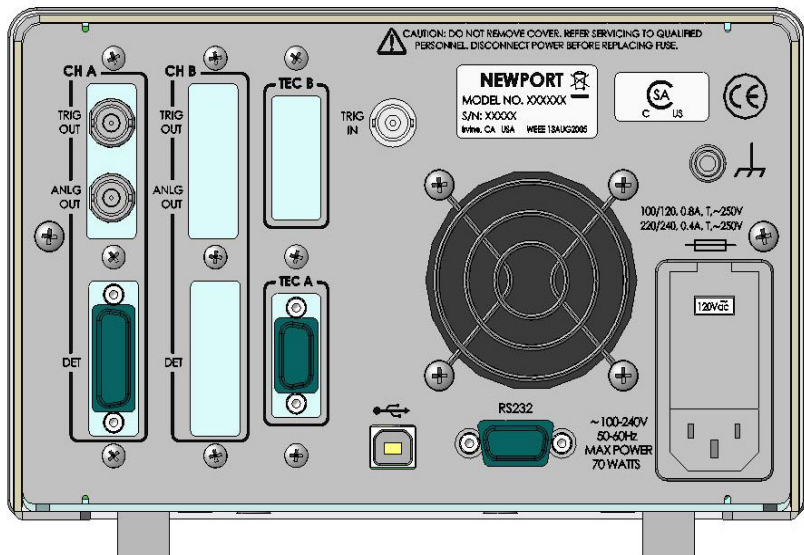

Figure 18 1935T-C Rear Panel Layout

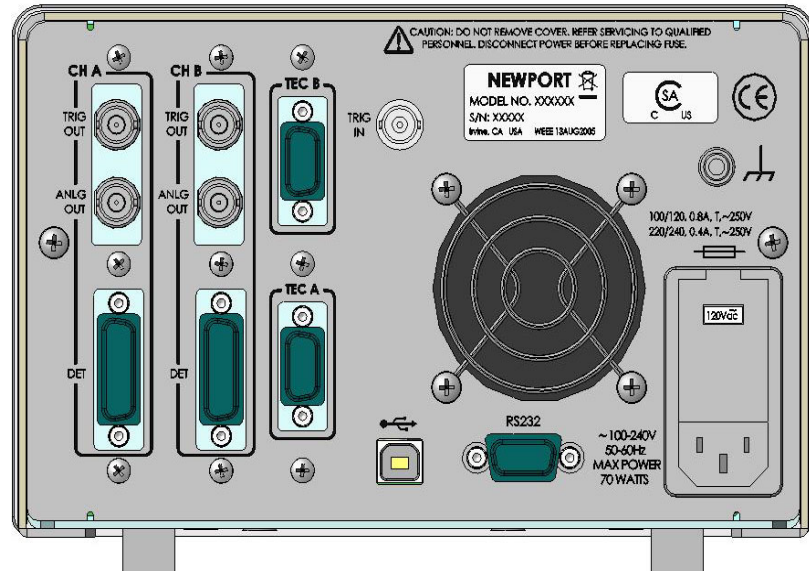

Figure 19 2935T-C Rear Panel Layout

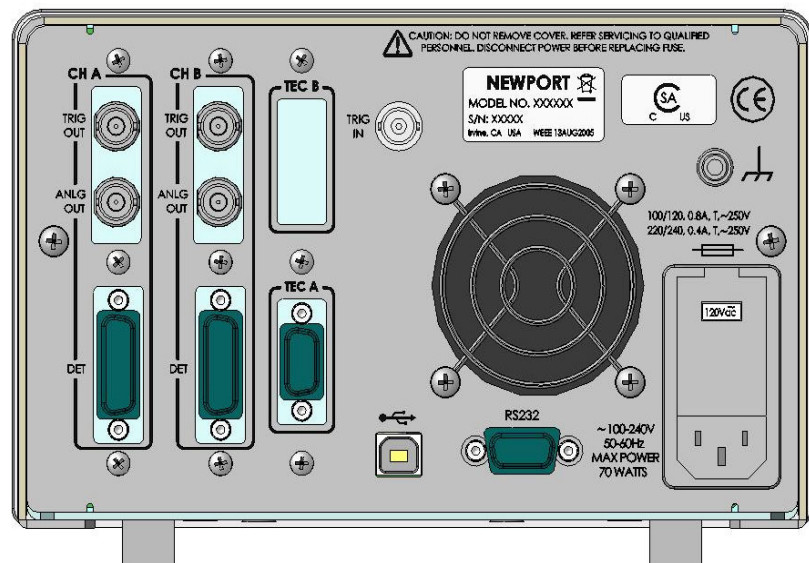

Figure 20 2935T-C-1 Rear Panel Layout

The rear panel also has an AC input power connector (IPC) with a standard three-prong socket and voltage setting switch.

The unit can also be grounded with a circular metal shell connector.

Markings on the rear panel identify electrical requirements for the Optical Power Meter and potential hazards associated with using it.

NOTE

For the listed optional connectors some units may have a cover in place of the non-functional connector.

	CAUTION
	Change the voltage settings switch to the proper AC voltage supply. Do not operate with a line voltage that is not within $\pm 10\%$ of the line setting. Too low of an input voltage may cause excessive ripple on the DC supplies. Too high of an input voltage will cause excessive heating.

	CAUTION
	There are no user-serviceable parts inside the power meter. Work performed inside the power meter by persons not authorized by Newport may void the warranty.

	WARNING
	To avoid electrical shock hazard, connect the instrument to properly earth-grounded, 3-prong receptacles only. Failure to observe this precaution can result in severe injury.

3.3.3 Changing Voltage Settings

The 1935/2935-C Series can operate on several different supply voltages. Before powering up the unit, check the facility AC voltage supply, and select the appropriate setting according to the procedure below.

Use the following procedure to change the 1935/2935 Series voltage setting:

1. Ensure that the 1935/2935 Series is turned OFF and disconnected from the AC power source.
2. Disconnect the power cord from the AC power input connector on the back of the 1935/2935 Series.
3. Using a small screwdriver, insert and press down into the notch at the top of the power entry module to pry the door open.
4. Carefully remove the voltage selector drum.
5. Rotate the voltage selector until the appropriate voltage will be viewed through the voltage window.

**CAUTION**

Do not rotate the voltage selector drum while the drum is inserted in its location. By doing so, you may bend the contacts behind the drum, making the unit inoperable.

6. Reinsert the voltage selector drum.
7. If necessary, change the fuses according to the procedure found in Section 10.2 Replacing Fuses.

**CAUTION**

Match the voltage setting to fuse sizing. Failure to do so may result in damage to the power meter. Do not exceed 250VAC on the line input.

8. Close the power entry module.
9. Verify the correct voltage is displayed through the voltage window.
10. Connect the AC power input cord to the AC power input connector on the back of the 1935/2935 Series.

3.4 Rack Mounting the 1935/2935 Series

Newport Corporation offers two rack mounting kits for the 1935/2935 Series: PM1-RACK (Figure 21) and PM2-RACK (Figure 22)

The PM1-RACK can house one unit from the 1935/2935 Series. In the PM2-RACK two units, either Model 1935 or Model 2935 or one of each, may be mounted side by side. PM1-RACK and PM2-RACK kits will only fit into 19" EIA style racks.

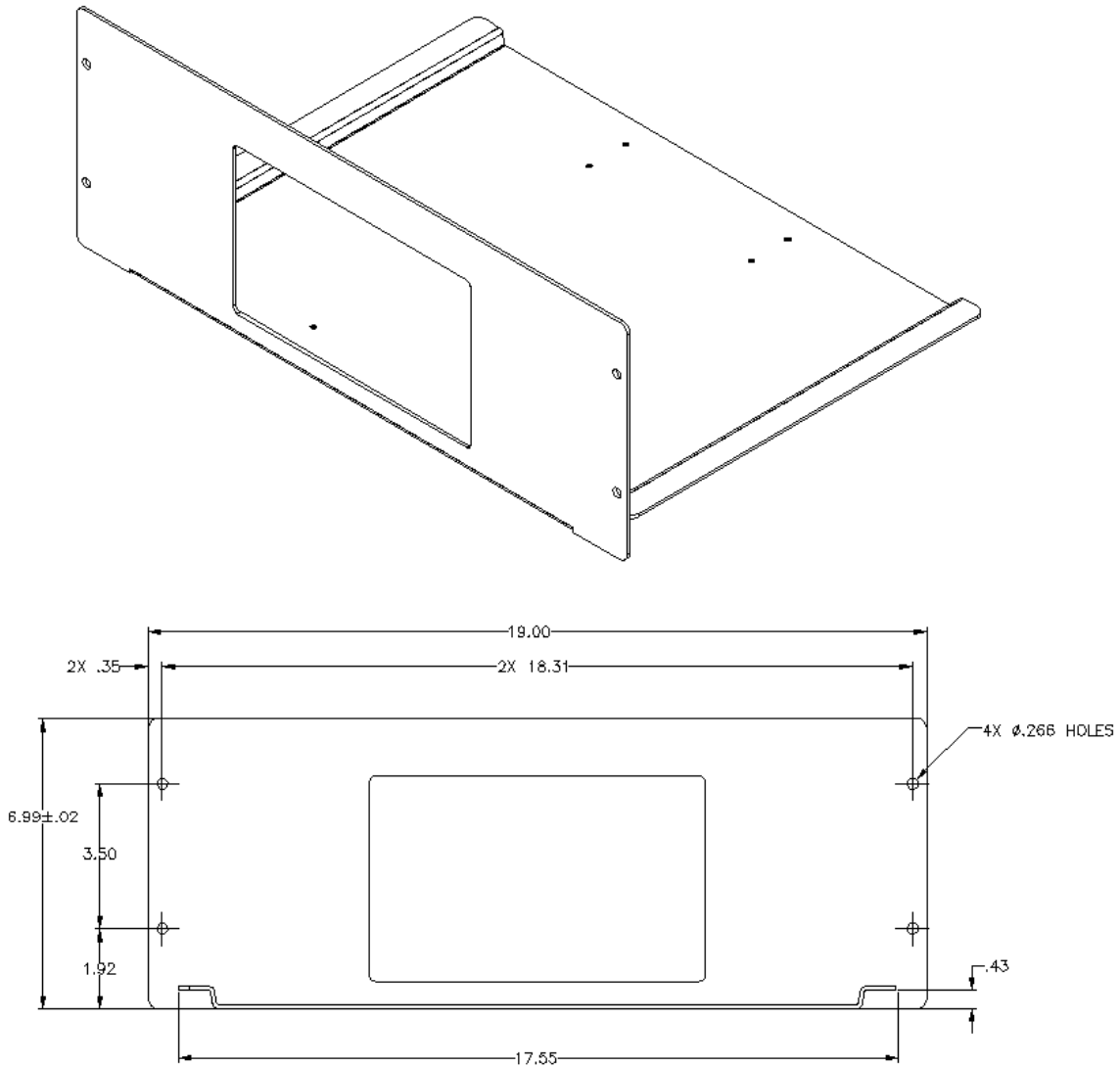

Figure 21 PM1 –RACK mounting kit

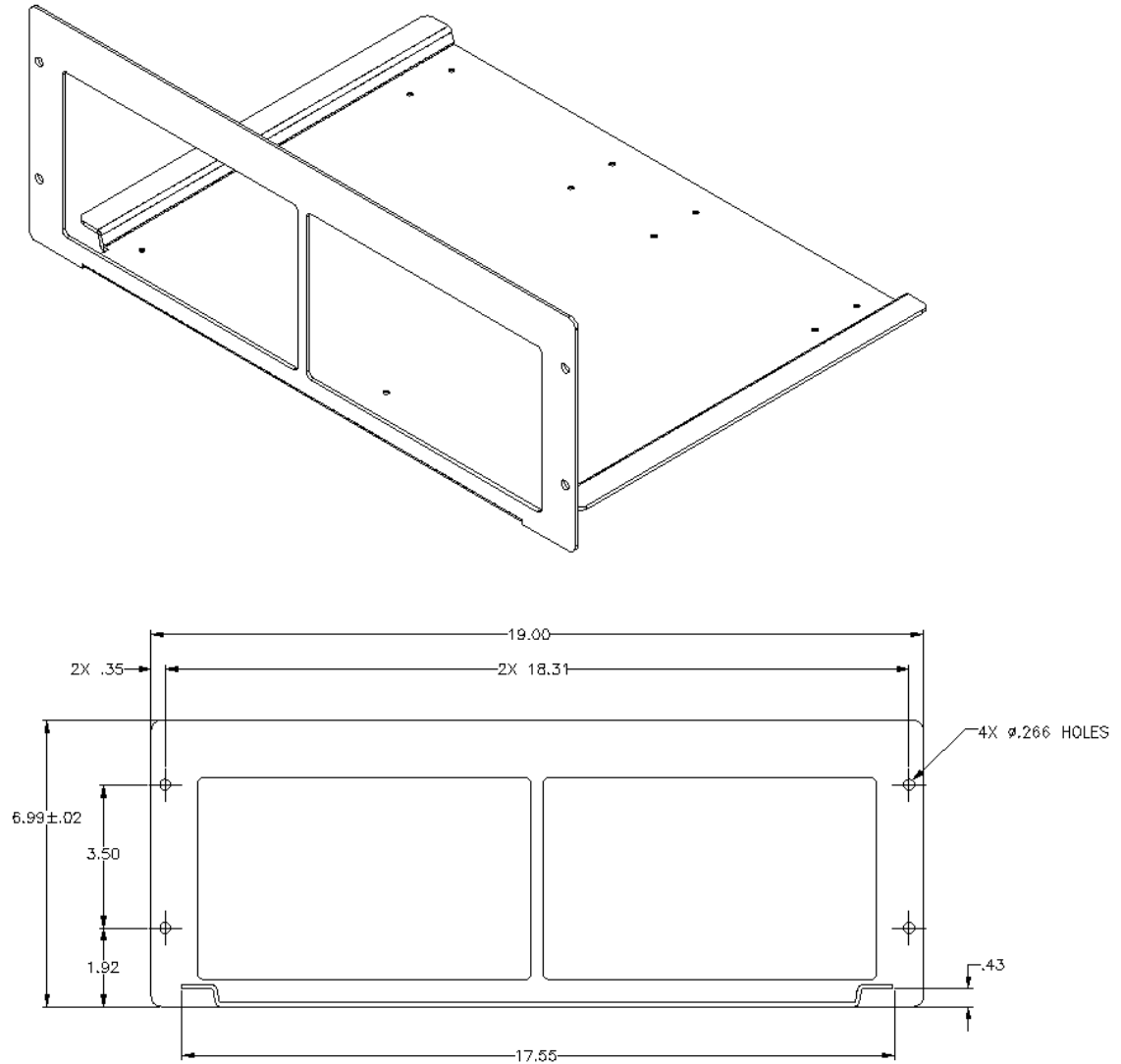

Figure 22 PM2-RACK mounting kit

To mount the units in these racks the user needs to remove the four feet at the bottom of the instrument. With the hardware supplied with the rack mount kits, the bottom of the unit(s) is secured to the bracket using all four original feet mounting positions (Figure 23). After tightening the screws the unit(s) may be slid into a 19" rack and secured to the side rails.

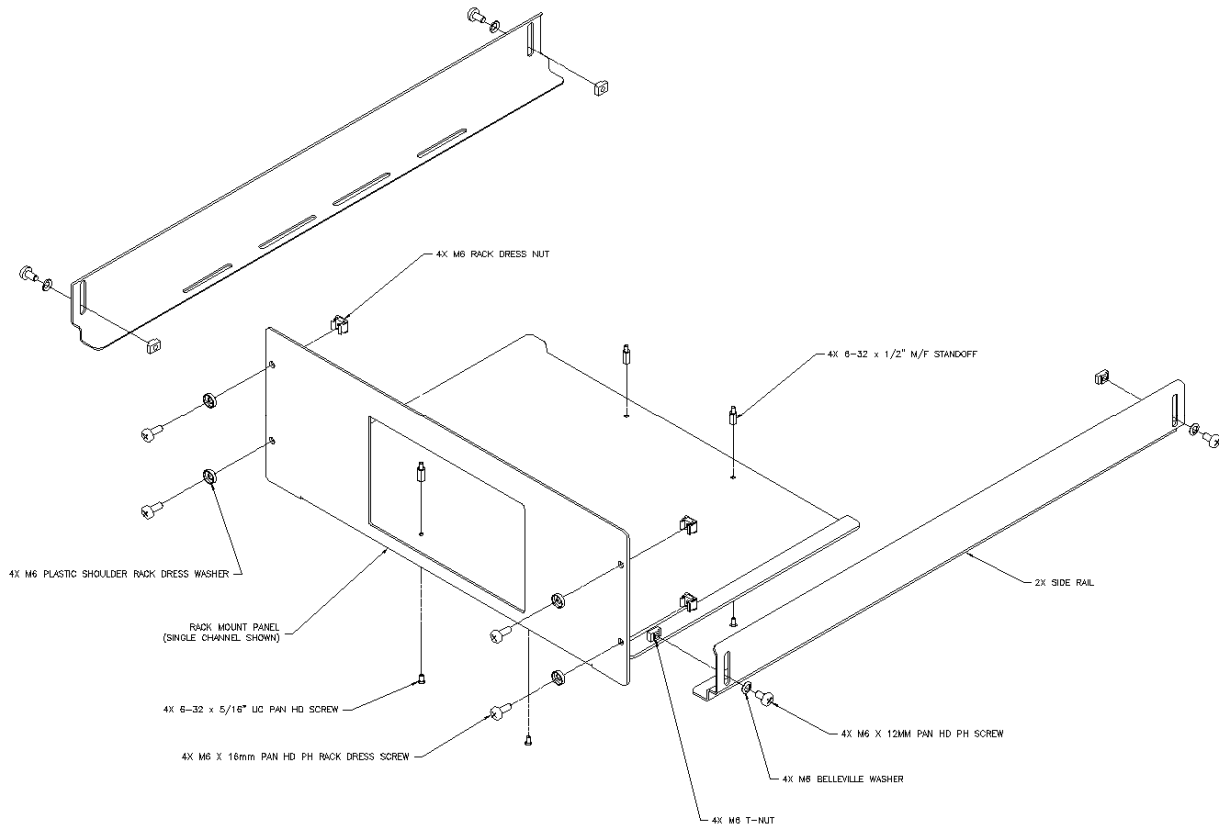

Figure 23 Mounting details for the PMI-RACK mounting kit

4 System Operation

4.1 Front Panel Keys

The front panel keys are organized in three groups (see Figure 24).

- Navigation Keys
- Reconfigurable (also called Soft) Keys
- Escape (ESC) Key

Besides these keys, the front panel has a Power switch and a USB connector on the left side of the instrument.



Figure 24 Front Panel keys

4.1.1 Power Switch



Figure 25 Power Switch

The power switch is a push button on the bottom left corner of the chassis that turns the unit on or off. The power switch is distinguished from other keys on the front panel by its circular shape. The power to the unit is OFF when the push button is fully extended and ON when latched.

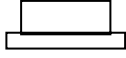
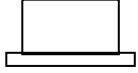
	<p>This symbol represents the IN position of the power ON/OFF push button switch</p>
	<p>This represents the OUT position of the power ON/OFF push button switch</p>

4.1.2 Setup/Enter Key

The Setup/Enter key is placed to the right of the display (Figure 26). This key has dual functionality. From the main screen (Figure 27) press this key to display the Measurement Settings screen (Figure 28). Also, use this key while any secondary menu is displayed to complete entering data, or to exit the current secondary screen.

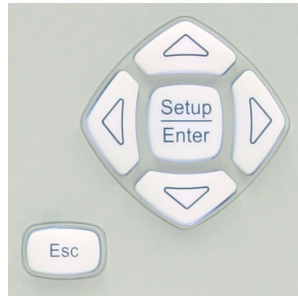

Figure 26 Navigation/Selection and Setup/Enter keys



Figure 27 Main screen

Measurement Settings			
Wavelength	458 nm	Detector	818-SL
Range	25.00 W	S/N	1234
Rng. type	Auto	Det. size	1.0000 cm ²
Attenuator	On	Ref. val.	1.0000 mW
Analog filter	5 Hz	Offset	0.0000 W
Digital filter	0	Det. temp.	25.0 degC
Units	Watts	Responsivity	1.000E-1
Mode	CW Cont.	Num. Digits	4

Show	System	Trigger	
------	--------	---------	--

Figure 28 Measurement Settings screen

Refer to Section 4.2 for more information about the measurement settings.

4.1.3 Esc Key

The Esc key (Figure 24 and Figure 26) is used to cancel the current action. When in a secondary screen or menu, it will close the current screen or menu and the instrument will return to the main screen (Figure 27).

4.1.4 Navigation and Selection Keys

Navigation through and selection of data in the display is done with the top right group of four arrows keys and with the Setup/Enter key (Figure 26).

Left and Right keys have dual functionality: Channel Swapping and Navigation.

Channel Swapping

When the instrument displays the main screen, pressing the Left or Right keys will cause the displayed channels A and B to be swapped.

If the meter displays channel A as primary channel and B as secondary, the top left corner shows “A” and the main numeric field in the middle of the screen shows the measurement in progress on channel A. The secondary channel, B in this case, is displayed in the upper right corner (Figure 29).

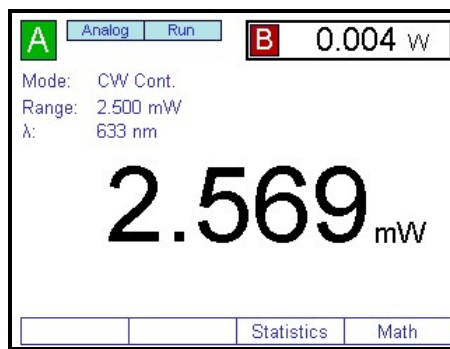

Figure 29 Channel A primary



Figure 30 Channel B primary

Pressing the Left or Right key of the Navigation and Selection group will make channel B primary and channel A secondary as in Figure 30.

Navigation

If the instrument is in Setup mode or in any configuration screens, pressing the arrow keys will select different setup modes as displayed by the current screen.

NOTE

When a channel is selected as primary, the main screen shows the primary channel and all the function keys whether dedicated or soft keys apply to the primary channel.

4.1.5 Soft Keys

Below the screen are a group of four keys. Their function varies, depending on the measurement mode or the setup screen. They are designed to provide context sensitive functionality to the user. The label displayed above each key indicates their function.



Figure 31 Soft keys

4.1.6 Dedicated Keys

Six dedicated function keys are at the bottom right portion of the front panel. Each of these keys can be used for quick access to the given function.

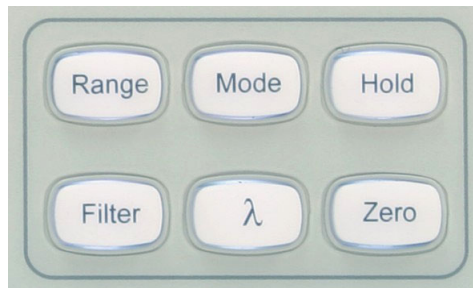

Figure 32 Dedicated keys

Range

Pressing this key reconfigures the Soft keys at the bottom of the screen as in Figure 32.

From this screen the user has two options.

- One is to toggle Auto/Manual Range mode. This is accomplished by pressing the left-most Soft key.

If the meter current configuration is Manual mode the left-most Soft key is labeled Auto to allow the user to change the Range selection in Auto Range Mode. This can be seen in Figure 33, where the range is 1.000 W indicating a manual mode.

If the instrument is in Auto Range Mode, the left most key is labeled Manual. The user may return to the main screen by pressing the ESC key (see Figure 34).

- The other option is to press the right-most Soft key, which is labeled Config. This action displays the Range Configuration screen. Here the user can select a certain range or even Auto Range with the Navigation/Enter keys. Once a range is selected the instrument returns to the main screen. While in Range Configuration screen, the user may cancel the selection by hitting the ESC key.

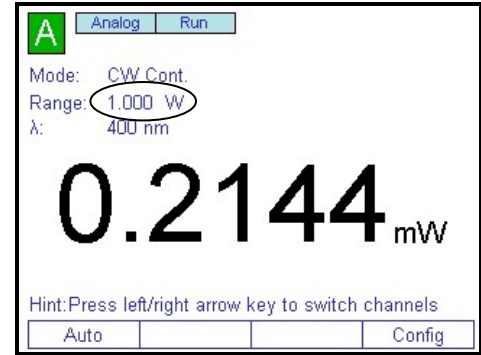

Figure 33 Manual Range mode

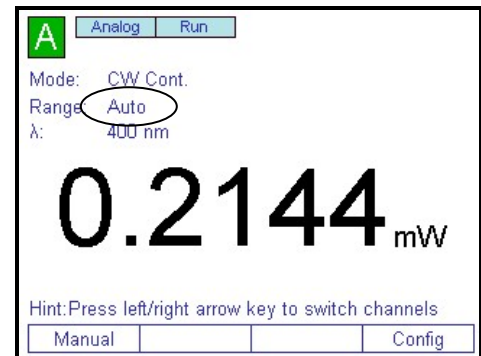

Figure 34 Auto Range mode

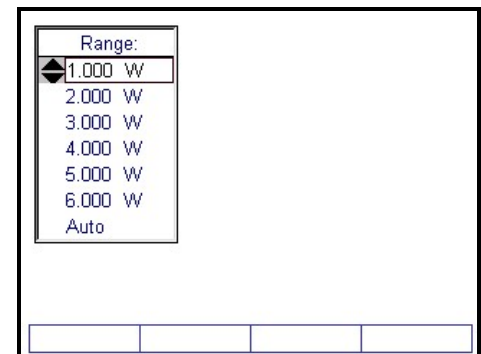

Figure 35 This screen is displayed after pressing the Config soft key

Mode

The Mode key displays a screen as in Figure 36. Using Navigation/Enter keys, the user can select different measurement modes or display modes according to his application. The ESC key cancels the selection and brings the instrument back to the main screen.

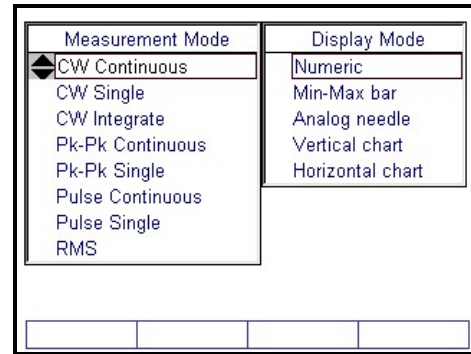

Figure 36 Mode selection screen

Hold

The Hold key toggles between holding the current measurement or running freely. When in Hold mode the numeric display freezes and the upper left corner of the display reads Hold (see Figure 37).



Figure 37 Measurement is on hold

The display starts running when the Hold key is pressed again and the upper left corner displays Run. The ESC key has no effect on Hold status.



Figure 38 Measurement is running

Filter

The Filter key allows the user to apply Analog or Digital Filters or both to the detector signal. This key brings a screen as in Figure 39. The Soft keys are reconfigured for the filter selection. Counting from left to right, the first key applies only the Analog filter to the detector signal, the second applies only the Digital Filter, and the third applies both filters. When the filters are selected, the corresponding label above the soft key has a highlighted background and the filter name is displayed in the upper left corner.

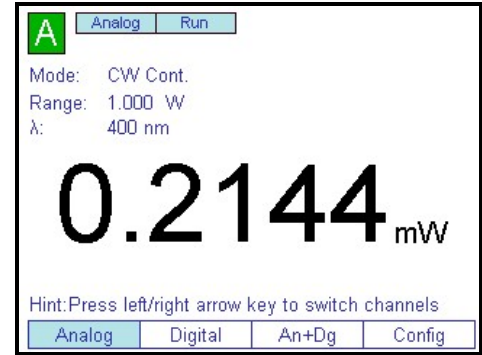

Figure 39 Filter selection screen

The fourth Soft key is used for filter configuration. When selected, a screen as in Figure 40 is displayed. Using the Navigation/Enter keys the user can select the filter of choice. If the Enter key is not pressed, the ESC key cancels the selection and brings the instrument back to the main screen. If the Enter key is pressed, a selection is made, and the instrument goes back to the main screen.

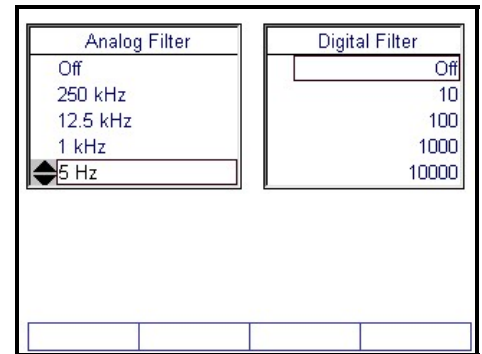

Figure 40 Filter configuration screen

The digital filter values can be edited. When one of the digital filter values is selected, the right most soft key becomes Edit Value. Pressing this Soft key displays a cursor on top of the first digit of the edited filter value. The Navigation Up/Down keys modify the digit, while the Left/Right keys move the cursor to the next digit. When finished, press the Enter key to store the new digital filter value and press Enter again to select the new value and exit the Filter configuration screen.

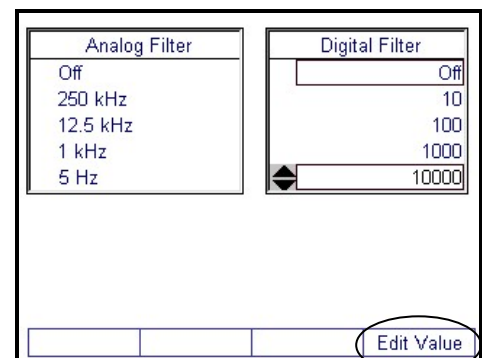

Figure 41 Digital Filter editing

Lambda (λ) Key

The Lambda (λ) key brings the Default and Custom Wavelengths screen. This screen allows the user to choose a default wavelength for the measurement in progress, or to choose a custom wavelength. See Section 4.4 for more details.

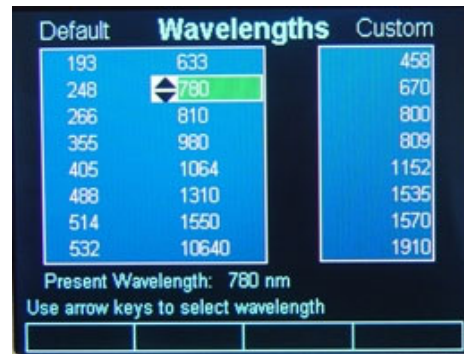

Figure 42 Wavelengths screen

Set Zero Offset (Zero Key)

The Zero Offset key, or short, Zero key is used to temporarily zero the instrument for the measurement in progress. When the user presses this key, the instrument takes the displayed numeric value as offset and subtracts it from all the subsequent measurements. When the instrument is zeroed the offset value is displayed on the main screen above the numeric value (see Figure 43).

The Zero key toggles the offset on or off. The ESC key has no effect on the Zero function.

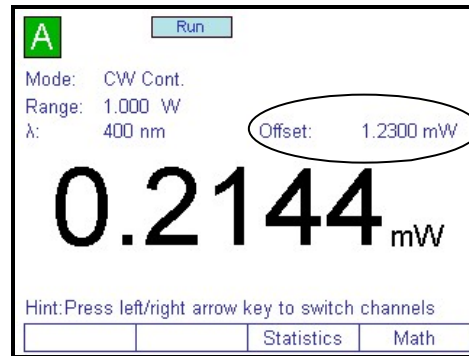

Figure 43 Zero Selection

4.2 Measurement Settings

The Measurement Settings screen has dual functionality:

- One is the convenience the user has to change all the measurement settings within one screen.
- The other is information presented to the user about the detector used.

From the default screen, when pressing the Setup/Enter key, the 1935/2935 Series displays the Measurement Settings screen as in Figure 44.

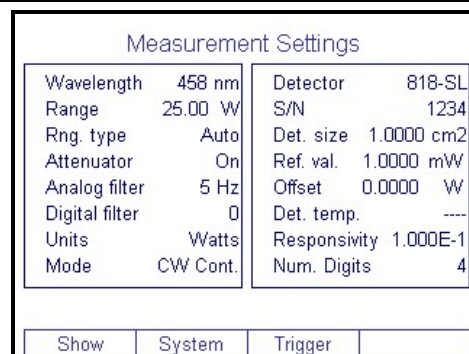

Figure 44 Measurement Settings screen

4.2.1 Changing the Measurement Settings

Within the Measurement Settings screen the user can select the Wavelength, Range, Range Type, Beam Attenuator, Analog Filter selection, Digital Filter selection, measurement Units, measurement Mode, and the Number of Digits displayed.

Wavelength Selection

With the Navigation/Selection keys bring the cursor on top of the wavelength field. Hit the Enter key. A drop-down menu appears with the custom wavelength values (see Section 4.4 for more information about the wavelength custom values). Select the desired wavelength and hit Enter.

Range Selection and Range Type (Rng. type)

The Range field has dual functionality:

- One is to display the current selected range whether it was selected by the user, in Manual Range Mode, or by the system, in Auto Range Mode.
- The other is to allow the user to change the range.

With the Navigation/Selection keys bring the cursor on top of the Range field. Hit the Enter key. A drop-down menu appears with the available ranges in the selected units. Select the desired range and hit Enter.

If the unit was in Auto Range mode, once a range is selected here, it will switch the system to Manual Range Mode. To bring it back to Auto Range Mode, navigate to Range Type (Rng. type) and change the range to Auto Range Mode. Also, the user has another option to bring the back into the Auto Range Mode. This can be done from the default screen where the user can change the Range to Auto Range Mode with the Range Dedicated key (see Section 4.1.6).

NOTE

The Auto Range Mode is disabled for Pulse Energy Measurements (818E Detectors). See Section 5.6 for more details.

Attenuator On/Off

If the detector is equipped with an integrated attenuator (e.g. 918D Series), the 1935/2935 Series detects its status (ON or OFF) and displays it in the Attenuator field.

The user has the option to manually set the attenuator to ON or OFF for detectors that have attenuators that can be manually mounted on the detector (e.g. 818 Series).

To change the attenuator status bring the cursor on top of the Attenuator field. Hit the Enter key. A drop-down menu appears with the ON/OFF option. Select the setting and hit Enter.

Analog and Digital Filter Selection

With the Navigation/Selection keys bring the cursor on top of the Analog or Digital field. Hit the Enter key. A drop-down menu appears with the available filter settings. Select the desired filter and hit Enter.

The Analog and Digital filter configuration can be accessed any time with the Filter dedicated key. Refer to Section 4.1.6 for details.

Units Selection

With the Navigation/Selection keys bring the cursor on top of the Units field. Hit the Enter key. A drop-down menu appears with the available units. Select the desired units and hit Enter.

Mode Selection

This setting allows the user to change the measurement mode. The available modes are as follows:

- Continuous Wave Continuous Run (CW Cont.)
- Continuous Wave Single Shot (CW Single)
- Continuous Wave Integral (CW Integ.)
- Peak-to-Peak Continuous Run (Pk-Pk Cont.)
- Peak-to-Peak Single Shot (Pk-Pk Single)
- Pulse Mode Continuous Run (Pulse Cont.)
- Pulse Mode Single Shot (Pulse Single)
- RMS Measurements (RMS)

Refer to Section 5, Performing Basic Measurements, for detailed information regarding these modes.

Number of Digits Setting

The 1935/2935 Series displays a default 4 number of digits. To change these settings bring the cursor on top of the Num. Digits field. Hit the Enter key. A drop-down menu appears with the option of 3, 4 or 5 digits. Select the desired number of digits and hit Enter.

Offset Field

On the right column of the Measurement Settings the unit displays the Offset stored when the user hit the Zero dedicated key. This value can be cleared or updated if the unit is in the default screen and Zero is pressed (see Section 4.1.6 for more information).

4.2.2 Detector Information

The Measurement Settings screen displays information about the detector used based on the data available in the detector calibration module or detector internal memory.

The available data are the detector model number (Detector), the detector serial number (S/N), the detector size (Det. Size), the reference value (Ref. val.) (see Section 4.8 for more information), the detector temperature

(Det. temp.) if the detector has an internal temperature sensor, and the detector responsivity (Responsivity).

4.3 Trigger Setup

The Trigger Setup screen can be accessed from the Measurement Settings (Figure 45). Pressing the Trigger soft key gives the user a few choices to setup the trigger according to the measurement needs.

The user has the option to send a trigger pulse at the Trigger Out BNC connector based on the Trigger In signal. Trigger Out can be delayed relative to the trigger input with Trigger Delay.

Measurement Settings			
Wavelength	458 nm	Detector	818-SL
Range	25.00 W	S/N	1234
Rng. type	Auto	Det. size	1.0000 cm ²
Attenuator	On	Ref. val.	1.0000 mW
Analog filter	5 Hz	Offset	0.0000 W
Digital filter	0	Det. temp.	---
Units	Watts	Responsivity	1.000E-1
Mode	CW Cont.	Num. Digits	4

Buttons: Show System **Trigger**

Figure 45 Accessing the Trigger Setup screen

The 1935/2935 Series has an advanced Trigger set that allows the user to synchronize measurements with external events. Synchronization can be achieved with Trigger Start and Trigger Stop which can be set both from the trigger setup screen or with external commands.

4.3.1 Trigger Delay

The Trigger Delay refers to the time delay between an event at the trigger input (e.g. rising edge) and corresponding event at the Trigger Output. The user has the possibility to change the delay between 150 ns and 210 seconds.

Besides the setup screen the user has the option to change the delay with an external command
PM:TRIG:HOLDoff (Section 8.3.3).

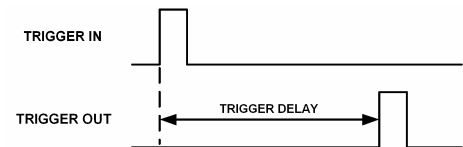

Figure 46 Trigger Delay waveforms

4.3.2 Trigger Start

The Trigger Start is an event that tells the system when to take a measurement or a group of measurements. It can be set in different ways.

- **Continuous.** The system is always triggered
- **External Trigger** (TTL Signal). The system is triggered when an external TTL signal is connected to the Trigger In BNC. The edge choice is set with an external command, PM:TRIG:EDGE (Section 8.3.3).
- **Soft Key.** The system can be triggered with a Soft Key that appears in the main screen.
- **Command.** The system is triggered with an external command, PM:TRIG:STATE (Section 8.3.3).

The Trigger Start can also be set with an external command PM:TRIG:START (Section 8.3.3).

4.3.3 Trigger Stop

The Trigger Stop is an event that tells the system when to stop taking measurements. In the case of a single measurement, a trigger stop event arms the system for the next measurement. It can be set in different ways.

- **Never Stop.** The system measures continuously.
- **External Trigger** (TTL Signal). The measurement stops when an external TTL signal is connected to the Trigger In BNC. The edge choice is set with an external command, PM:TRIG:EDGE (Section 8.3.3).
- **Soft Key.** The system stops measuring when a Soft Key is pressed. This key appears on the main screen.
- **Command.** The system stops measuring when an external command, PM:TRIG:STOP (Section 8.3.3) is sent via USB or RS232.
- **Value.** The system stops measuring when the measured signal crosses a user programmed value.
- **Time.** The system stops measuring when a user programmed time passed between the Start event and the current measurement.
- **Number of Samples.** The system stops measuring when a user programmed number of measurements passed between the Start event and the current measurement.

The Trigger Stop can also be set with an external command PM:TRIG:STOP (Section 8.3.3).

4.4 Wavelength Setting

Newport detectors have a calibration module or internal memory which stores the Responsivity versus Wavelength Table. If the Lambda key is pressed, a wavelength screen is displayed with the most common values in nanometers (nm) (see Figure 42 on page 48).

The screen has two columns. The left column displays the common wavelength values used in the industry, while the right column has custom values.

When the user selects one of the predefined wavelengths in the left column, the 1935/2935 Series looks up the wavelength in the responsivity table in the detector calibration module. If that exact value is found, the system will use the corresponding responsivity for that particular wavelength. If the value is not found, the system will calculate the responsivity using interpolation.

The right column in the Wavelength screen gives the user the option to set custom wavelengths. To do so, with the Navigation keys bring the cursor on top of one of the numbers. The rightmost Soft key becomes Edit Value. Hit this key to edit the custom number. A white cursor appears on the first digit. Press the Up/Down navigation keys to change the number and the Left/Right keys to move to the next digit. When finished, hit Enter. The new custom wavelength will be stored. Press Esc to return to the main screen

4.5 Display Color

In a laboratory environment, and especially when one uses protective eyewear, it may be desirable to change the meter display color to accommodate the eyewear color. The instrument has predefined color schemes that can be changed any time (Figure 47).



a. Negative black and white screen

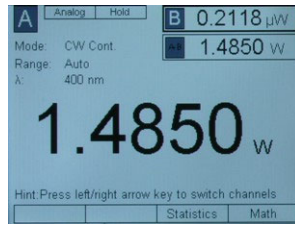

b. Positive black and white screen



c. Red screen



d. Green screen



e. Blue screen



f. Color/Blue screen

Figure 47 Predefined color schemes

To change the display colors first press the Enter/Setup key. This will bring the Setup screen and reconfigure the Soft keys (Figure 48).

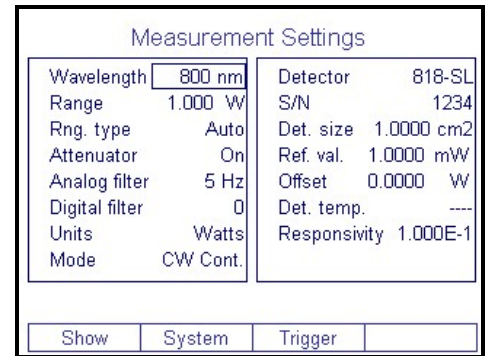

Figure 48 Setup screen

Pressing the System soft key will bring a secondary setup screen. Navigate to the Color Selection to change the screen color (Figure 49). Also, navigate to the Brightness field and hit Enter to change the screen brightness. The default value is 100%. Press the Measure soft key to go back to the Measurement Settings screen, or press ESC to go back to the main screen.

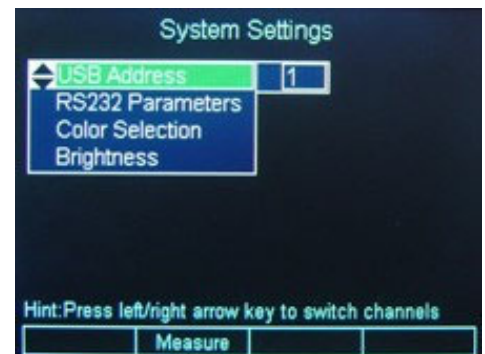

Figure 49 System Settings screen

4.6 USB Address and RS232 Parameters

The USB Address can be changed in the System Settings screen (Figure 49). Navigate to the USB Address and hit Enter. In the drop-down menu select the desired USB address. The RS232 Parameters are fixed at Baud Rate 38400, Data Bits 8, Stop Bits 1, Parity None, Xon/Xoff Xoff.

4.7 Statistics

The 1935/2935 Series can display statistics for the measurement in progress. From the main screen press the Soft key labeled Statistics. The Statistics screen is displayed as in Figure 50.

The left column shows the statistics current setup. The Statistics function has two modes: Fixed and Continuous.

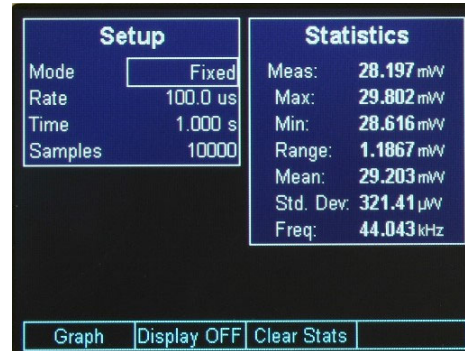

Figure 50 Statistics screen

When in Fixed mode the Statistics engine calculates the minimum (Min), maximum (Max), Range, Mean, Standard Deviation (Std. Dev.) for a fixed number of samples and displays them in the right column.

The number of samples is displayed in the left column on the Samples line. As Figure 50 shows, the number of samples is 10000 with a time interval between samples of 100 μs. This means that the statistics values are calculated over 1 second interval.

If the Mode is Fixed, at the end of the 10000 samples, the statistics values are cleared and the calculation starts again with the next measurement.

The user can change the Mode with the Navigation keys. When the Enter key is pressed a drop-down menu allows the user to select Fixed or Continuous Mode. By using the Up and Down navigation keys followed by Enter, the user can change the Mode to Continuous.

In Continuous Mode the statistics calculations are done over the same number of samples, 10000, but these samples are updated in real time in a first-in-first-out (FIFO) fashion. The system starts filling up the list of 10000 and calculates the statistics with the available number of samples at hand. When the list is filled, as the next sample comes, the system drops the first measurement in the list, number 1, shifts the entire list down, and places the next measurement on the 10000 level. The statistics are recalculated for the new list and the process repeats with the new measurement.

The Soft keys offer the user the option to clear the statistics at any time, with Clear Stats soft key, and to return back to the default screen with Display OFF soft key.

The Graph soft key (Section 4.7.1) can be used for the visualization of the

measured values on a time graph.

The Statistics screen displays also the current measured value at the top of the right column. At the bottom of the same column the system displays the primary channel signal frequency. Section 5.9 gives a more in depth description of the Frequency measurement.

4.7.1 Graph

The Graph soft key displays the last 10000 measurements on a time graph (Figure 51). Due to the sample time interval of 100 μ s, the graph duration is 1 second. The graph width is 270 pixels and, because of that, the system has to decimate the 10000 samples to fit them in this fixed number of pixels. Therefore, the graph might look choppy if the graph zoom is set on 1.

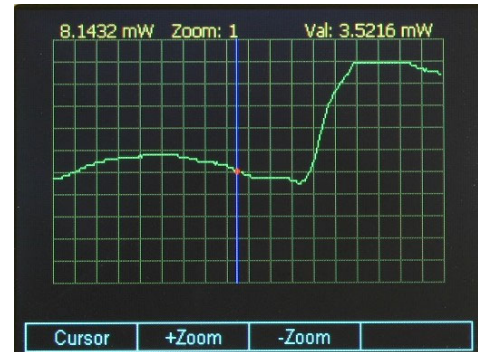

Figure 51 Graph screen

The user can zoom into the graph with the Soft keys +Zoom and -Zoom. As the zoom changes the graph displays a finer picture of the measurements. The zoom value is retained at the top of the screen. Pressing the +Zoom soft key will zoom in the graph 2 times the previous zoom value. Pressing the -Zoom soft key will zoom out $\frac{1}{2}$ times the previous zoom value.

The maximum graph value is displayed in the upper left corner of the display. If the Cursor soft key is pressed, a vertical line (cursor) is displayed. The user can direct the cursor left or right with the Navigation Keys to read the measured values on the graph. The current value is displayed in the upper right corner and marked on the screen with a red dot.

4.8 Math Functions

The Math function is displayed on the math field, at the upper right side, just below the secondary channel field (Figure 52). To display the Math field the user selects the soft key labeled Math in the main screen. This in turn displays the math configuration screen

The Math function can be used to add, subtract, multiply or divide channels A and B in real time.

Once in the Math configuration screen the user can use the



Figure 52 Math field

Navigation keys to build the mathematical expression. From the first column the user can select the first variable in the expression, from the second column, the operator, and from the third column, the second variable. When the selection was made, the system returns to the main screen after the Enter key was pressed.

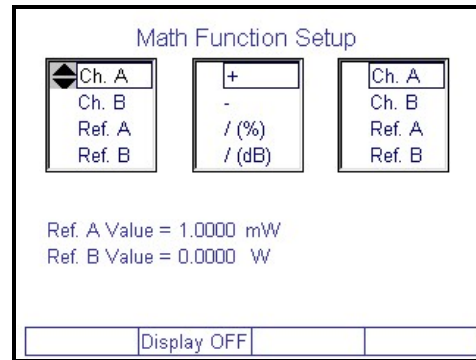

Figure 53 Math configuration screen

The same mathematical operations can be performed between either channel A or B current display and a stored value called Ref. A or Ref. B.

Ref. A and Ref. B are assigned a default value of 1 when the system is first turned on. The reference values are stored and displayed in the selected units. The user can change the reference values with a remote command

PM:REF:VAL *value*

as described in Section 8.3.

If the displayed units change, then the user needs to update the stored reference value so that the system will store the new units in the reference.

The Math field can be turned off from the math configurations screen. The second Soft key is labeled Display OFF. If this key is pressed the system return to the default screen and the Math field disappears.

4.9 Display Modes

The selection of various display modes can be done from the default screen, by pressing the Mode soft key. When the Mode selection screen is displayed (Figure 54), the display mode can be selected from the second column.

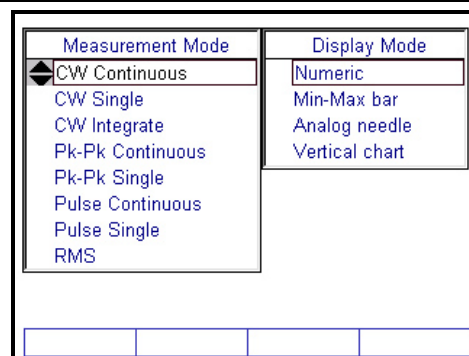

Figure 54 Mode selection screen

4.9.1 Numeric Display

The numeric display is the default display of the 1935/2935 Series. The numeric display shows the current measured value of the primary channel.

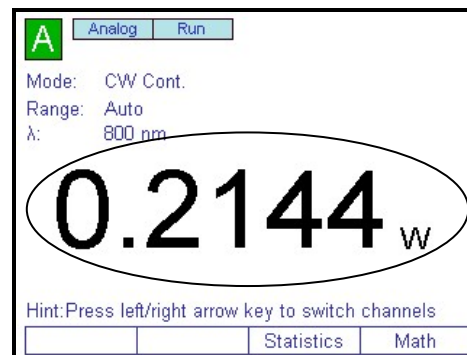

Figure 55 The Numeric display

4.9.2 Analog Bar

The Analog Bar display mode brings a bar graph below the numeric display. The bar graph is white and follows the value showed by the numeric display. The minimum and maximum labels displayed just below the bar graph represent the input range the unit is currently set on. For example, if the unit is set on 182.7 mW range, then the bar graph shows the same range of 0 to 182.7 mW. In the middle of the bar graph the displayed number is the middle of the range.



Figure 56 Analog Bar

The major ticks represent 10% of the range, and the minor ticks represent 5% of the range.

If the Soft key labeled Show Max is selected, the maximum value is retained and displayed in the bar graph with red color. The red bar is updated with each measurement, if the current measured value is larger than the largest of the previous measurements. Besides the maximum value being displayed with a red bar, the actual value is displayed above the bar graph where “Max=” shows the value. If the Soft key labeled Show Min is selected, the minimum value is retained and displayed in the bar graph with green color. The green bar is updated with each measurement, if the current measured value is smaller than the smallest of the previous measurements. Besides the minimum value being displayed with a green bar, the actual value is displayed above the bar graph where “Min=” shows the value.

The maximum and minimum bars can be reset with the Reset m/M soft key.

For users who would like to fine adjust a maximum or a minimum, the 1935/2935 offer the Auto Zoom function. When the Auto Zoom soft key is pressed another bar appears above the Analog Bar. The bar length is 2% of the Analog Bar. It is a display of the region around the end of the analog bar.



Figure 57 Auto Zoom

The Auto Zoom bar displays with white the current measured value, as the Analog Bar does. However its trip is more sensitive, because the maximum trip is +/-1% of the Analog Bar. If the Show Max or Show Min soft keys are pressed, the system behaves the same as with the Analog Bar, displaying with red the maximum value and with green the minimum value. As an example, as Figure 57 shows, the red bar in the Analog Bar is very small, so with the Analog Zoom this bar is extended giving the user the convenience to see better small signal variations.

Pressing the Reset m/M soft key, clears the minimum and maximum bars from both the Analog Bar and the Auto zoom graphs.

4.9.3 Analog Needle

The Analog Needle displays a vertical marker that moves with the displayed numeric value. It is useful for users who look for a maximum or a minimum when adjusting the optical power.

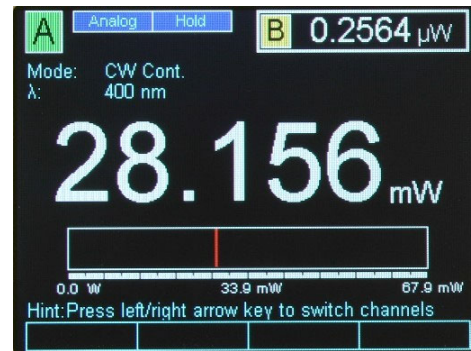

Figure 58 Analog Needle display

4.9.4 Vertical Chart

When the Vertical Chart is selected the numeric display is moved in the upper right corner, just below the secondary channel display. The vertical chart scrolls down, representing a snapshot of the last measurements. The chart can be cleared with the Clear soft key. The maximum peak value of the chart is the maximum measurement of the entire chart, since the last clear. Below the chart, there is a line with the chart maximum and minimum in major units. On the same line in the middle, there is information about the chart zoom level, e.g. 2x, and the number of samples processed per chart line, e.g. 10 Avg (Figure 59).

The chart has 100 lines, each line having a white and red color. When the system fills up a line, it looks at a number of samples defined by the number displayed below the chart.

Figure 59 shows 1x -- 10 Avg, which means that, while painting a line, the system looks at the previous 10 measurements. It displays with white the minimum value in the 10- measurement list and with red the maximum value in the same list.

The user can change the number of measurements by selecting the Average soft key and then pressing the Right or Left Navigation keys, to increase, respectively decrease the number of measurements. If one measurement is selected, the chart color is white, because the maximum and minimum per line are the same (Figure 60). Due to one measurement display per line, the chart speed increases.

If the Zoom soft key is pressed the user can zoom into the chart with the Up and Down Navigation keys



Figure 59 Vertical chart with 10 measurements per line

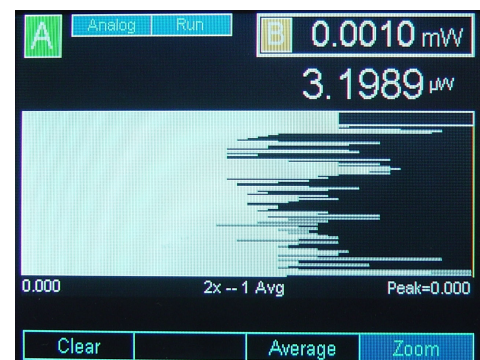

Figure 60 Vertical chart with 1 measurement per line

4.10 Cooled Detectors Operation

The 1935T-C/2935T-C Series can operate cooled detectors. These models have a TEC (Thermoelectric Cooler) Controller with one (single channel) or two (dual channel) DB-9 connectors at the Rear Panel (Section 3.3).

When a cooled detector's DB-15 connector is plugged into an analog channel, and its DB-9 connector is plugged into a corresponding TEC channel, the power meter will automatically cool the detector to its desired temperature set point. A "Cooling..." message is shown on the main measurement screen during the transient period. Furthermore, if "PM:P?" command is issued to query the power during this period, an invalid value (3.4028e+38) is returned. Once the detector's actual temperature reaches its set point, the "Cooling..." message disappears, and a true power measurement is shown on this screen.

If the cooled detector's DB-9 connector is disconnected from the corresponding TEC channel, a "TEC Cbl?" message is shown on the main measurement screen. If the cooled detector's DB-15 connector is connected to a power meter without the TEC option (1935-C/2935-C, for instance), a "Inv. Det." message is shown on the main measurement screen. Under both these conditions, if "PM:P?" command is issued to query the power, an invalid value (3.4028e+38) is returned.

4.11 Firmware Upgrade Procedure

Firmware Upgrade is an easy, straight-forward process. Simply copy firmware files (PM2935APP.EXE and XMLFILE1.XML) to a WinCE compatible USB Flash Drive and then plug it into the USB connector on the front of the instrument. Then wait a few seconds for the instrument to recognize the USB Flash Drive. The power meter will detect the new firmware files and will ask if you want to download the files. Press the "Yes" softkey to start the upgrade process. The power meter will instruct you to restart once the upgrade is successful. Restart the power meter by turning it OFF and back ON. The power meter will restart running the new firmware.

New firmware files may be available either through the Newport web site (<http://www.newport.com>) at the product page or through your local Newport application specialist.

5 Performing Basic Measurements

5.1 Introduction

Many different types of optical measurements are possible using the 1935/2935 Series of Power Meters. Most of these possible measurements are selected from within the MODE menu. This chapter discusses these measurements.

5.2 Measurement Modes and Units

The Model 1935/2935 provides a number of measurement modes for acquiring data. At power on, the meter checks the detector's calibration EEPROM to determine the available measurement modes supported by the detector.

Measurements can be displayed in various units. The detector type and the measurement mode determine the set of units available at any given time. Table 1 illustrates the measurement modes and units available for each detector family. The measurement modes are grouped naturally into three categories: CW, Peak-to-Peak (Pk-Pk), and Pulsed. Each will be discussed in the sections below.

The 1935/2935 Series sets the measurement to a detector specific default mode depending on the detector used. All Newport detectors have internal logic or calibration modules. Based on the data stored in detectors, the instrument knows to auto configure itself and sets up the mode, range, filter, rate, etc. The user, in the setup screen, can change the detector specific default mode.

The basic measurement techniques for using the 1935/2935 Series are covered in the following sections. Refer to Table 1 for a review of the 1935/2935's functions and measurement capabilities.

Detector Family	Mode	V	A	W	W/cm ²	J	J/cm ²	Hz	dB	REL (%)
Low-Power (918D-Series)	CW Continuous		X	X	X				X	X
	CW Single		X	X	X				X	X
	CW Integrate					X	X			
	Pk-Pk Continuous		X	X	X			X	X	X
	Pk-Pk Single		X	X	X				X	X
High-Power (818P-Series)	CW Continuous	X		X	X				X	X
	CW Single	X		X	X				X	X
	CW Integrate					X	X			
Energy (818E-Series)	Pulse Continuous	X				X	X	X		X
	Pulse Single	X				X	X			X

Table 1 Available Measurement Modes and Valid Units.

The following instructions assume familiarity with the meter's functions. They also include steps to incorporate background correction and assume that the experimental setup under-fills and does not saturate or damage the detector.

5.3 CW Measurements (with 918D or 818P Detectors)

This section describes the procedure for making basic optical power measurements while properly removing the influence of ambient light and other drift effects.

- With a 918D (also 818-XX lower power detectors with proper adapters) or 818P-Series Detector connected to the meter, turn the meter on. Press the Mode key and then select CW Continuous with the Navigation keys. Use the ESC key to return to the Main screen. Set Range to Auto and press the Lambda (λ) key to set the measurement wavelength to the desired value.
- Cover or otherwise block the light source being measured and then press the Zero key to turn the Offset on. This effectively removes any background signal from subsequent measurements.
- Uncover the source so that it illuminates the detector and note the displayed value. This reading is the optical power observed by the detector due to the source.

This process assumes that the ambient signal is not changing between the time when the Zero key is pressed and when the measurement is made. The user should remember that, if he/she can see the detector active area as he/she moves around, then the detector registers this as a changing ambient DC signal!

- For the 918D series detectors (also 818-XX lower power detectors with proper adapters) you can decide whether to use the attenuator for your measurement or deactivate (or physically remove on 818 low power series) the attenuator.
 - a. For very low power measurements, pW to uW range in various ambient light environments, you can elect to use the detector with no physical attenuator in the optical path. This will increase the sensitivity and hence accuracy of the measurement.
 - b. In case of higher power measurement, the attenuator should be used to avoid damage or saturation of the detector. The attenuator use is recommended in mW to low Wattage range incident power. Please refer to the specifications of the particular detector to make sure you do not exceed the saturation levels of the detector.

For the 918D series detectors with integrated (non-removable) attenuators, there is a switch built into the detector head, sensing the position of the attenuator. The power meter will then automatically use proper calibration data for presence or absence of the attenuator in front of the photo diode. For models such as 818 low power series detectors which have a removable attenuator, there is no switch built into the detector head, hence the user will have to manually select attenuator option status on the meter to obtain the proper power or signal readings.

5.4 Peak-to-Peak Power Measurements (918D Detectors)

This section describes the procedure for making basic optical peak-to-peak power measurements.

- With a 918D Low Power Detector connected to the meter, turn the meter on. Set the Mode to Pk-Pk Continuous. Set Range to Auto and press the Lambda (λ) key to set the measurement wavelength to the desired value.
- Illuminate the detector and note the displayed value. This reading is the peak-to-peak optical power observed by the detector.
- Accurate peak-to-peak power measurements can be made for pulse repetition rates up to 20 kHz.

5.5 Power Ratio and Power Reference measurements

This section describes how to use the mathematical functions in the power meter to obtain dB, Power or signal comparison, or ratio measurements.

- For single detector, you can obtain a ratio, dB or other comparison in reference to a previously saved value. Refer to Section 4.8 for information on setting the reference values.
- For dual detectors, you can obtain a live ratio or other comparison of the two channels displayed.
 - c. Use soft key labeled “Math” to enter the math function screen.
 - d. Select the channels and the functions by using the up, down, right and left arrow keys. Use the Menu/Enter key only after all your selections are made.
- **Example 1** – In order to select dB ratio of channel A to channel B:
 - e. While in the Math function screen, select channel A by using the up or down arrow keys. There will remain a black border around the highlighted/selected channel as you leave the column for the next selection.
 - f. Move to the next column by using the right arrow key, and select “/(dB)” option.
 - g. Move to the last column by using the right arrow key and use the up or down keys to select channel B.
 - h. Press the Menu/Enter key to accept the selections and exit the Math function screen.
 - i. The result of A/B in units of dB will appear in the designated window on the screen.
- **Example 2** – in order to get differential values of channels A and B:
 - j. From the main screen of the meter, select soft key labeled “Math” to enter the math function screen. If you cannot see the label “Math”, press the “ESC” key.
 - k. Use the direction keys to highlight channel A in the first column
 - l. Using the direction keys, navigate to the “-“ sign in the center column.
 - m. Using the direction key, move the final column such that “Ch. B” is highlighted.
 - n. Press the Menu/Enter key to retain the settings and exit the screen at the same time.
 - o. The result of A-B will be displayed in the designated window of the main display screen.

5.6 Pulse Energy Measurements (818E Detectors)

This section describes the procedure for making basic optical pulse energy measurements.

- With an 818E Energy Detector connected to the meter, turn the meter on. Set the Mode to Pulse Continuous. Set the Range to Manual Mode and press the Lambda (λ) key to set the measurement wavelength to the desired value.
- Illuminate the detector and note the displayed value as the meter measures each laser pulse. These readings represent the energies of the incident laser pulses. The meter will display the last pulse energy measured until a new pulse arrives.
- Accurate measurements can be made for pulse repetition rates up to 10kHz, depending on the limitation of the specific detector in use, of course.

For Pulse Energy Measurements the Auto Range Mode is disabled. The reason is the fact that the power meter has an advanced engine that allows for Pulse-by-Pulse measurements rather than Pulse Amplitude Averaging. Measuring the laser pulses in pulse by pulse mode gives the user more information about the laser behavior versus averaging. The drawback is that, in Pulse-by-Pulse measurements, there is always a possibility that two or more adjacent pulses fall in between ranges forcing the power meter to try to auto range quickly. The result would be an unreadable display. The user needs to set the power meter range based on a priori knowledge about the signal he measures. The behavior is similar with setting the range on an oscilloscope.

5.7 Signal Integration Measurements (918D or 818P Detectors)

This section describes the procedure for making a basic signal integration measurement while properly removing the influence of ambient light and other drift effects. The 1935/2935 Series begins and ends the signal integration every second.

- With a 918D or 818P Detector connected to the meter, turn the meter on. Set the Mode to CW Continuous. Set the Range to Auto and press the Lambda (λ) key to set the measurement wavelength to the desired value.
- Cover or otherwise block the light source being measured, turn Zero on and then set the Mode to CW Integrate. Immediately upon entering the integration mode, the meter will begin to acquire and integrate data. The display value may reflect the integration of noise due to ambient temperature fluctuations (when using the 818P detectors) or light fluctuations (when using the 918D detectors).

- Uncover or trigger the source. The displayed value should now reflect the detector signal integration value.

NOTE

This process assumes that ambient signals are not changing between the moments when the user zeros the display and when the measurement is made.

5.8 Measuring Laser Pulse Energy with an 818P Thermopile Detector (Single Shot)

This application makes use of the 1935/2935 Series' CW Integrate mode (see Section 5.7 above). When an optical pulse with energy $E(\lambda)$ is incident on a thermopile (818P Series), a voltage signal is generated at the detector input as the heat pulse flows out to the cooling fins. The sum of a series of integrated signals (each one second long) resulting from this heat pulse is a measure of the optical pulse energy, see Figure 61.

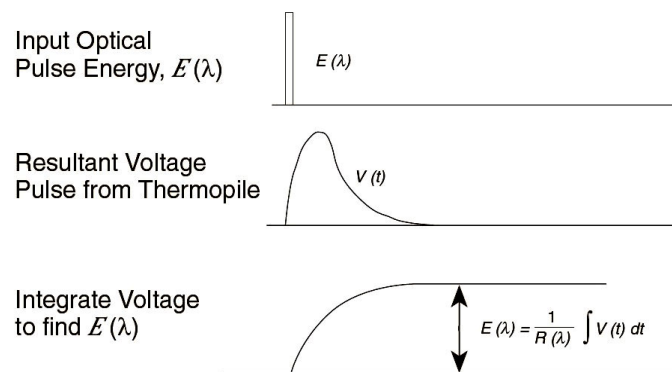

Figure 61 Measuring Laser Pulse Energy via a Thermopile in CW Integrate Mode

A recommended procedure is:

- With an 818P High Power Detector connected to the meter, turn the meter on. Set the Mode to CW Continuous. Set the Range to Auto and press the Lambda (λ) key to set the measurement wavelength to the desired value. Set Zero on and then change Mode to CW Integrate.
- Before the optical pulse arrives, the display may reflect the integral of detector noise due to ambient temperature fluctuations.
- Trigger the laser pulse. The display will display a new integrated energy measurement every second. The readings will start decreasing rapidly after the first couple of measurements due to the decline in heat flow from the relatively slow thermopile detector.
- When the displayed reading drops again to the point of essentially displaying the detector's noise component, the individual stored readings may be retrieved via the USB interface. Summing these readings will yield the pulse energy.

NOTE

This method works best if the integrated result of the pulse signal is much larger than the integral of the detector's noise component. If the integrated result of the pulse is not much larger, then error in the measurement will arise due to the uncertainty generated by integration of the noise component terms.

NOTE

The time constant of a thermopile detector determines the amount of time that one should expect to wait when making an integrated energy measurement of an optical pulse. Typically, an accurate value will be arrived at 5 time constants after the arrival of the optical pulse. Refer to the detector's manual for the proper time constant.

5.9 Frequency Measurements (918D or 818E Detectors)

The Frequency Measurement in the 1935/2935 Series is a background task. It runs all the time and the user can access it via the Statistics screen (see Section 4.7). Because of this advanced way of measuring the frequency, the user has the convenience to “take a look” at the signal frequency as needed, just by pressing a key. By doing so, the user does not need to change the current optical power measurement in progress, just to know what the repetition rate is. Moreover, as explained in Section 4.7, when using the Statistics screen, the user has an instant view of the input signal regarding Frequency, instant measured value, Minimum, Maximum, Mean, Standard Deviation, Signal Range.

The 1935/2935 Optical Meters have the capability of measuring the modulation frequency, or repetition rate, of the incoming optical signal with frequencies as low as 0.5 Hz on most ranges and up to 200 kHz. Below 0.5 Hz the measurement error will increase, and in some cases the measurement will freeze. Frequencies below 0.5 Hz cannot be measured. Refer to the Specifications table (Section 2.8) for the actual frequency limits depending on range and mode of operation.

In order to perform an accurate frequency measurement, the AC signal amplitude must be higher than 5 % of the full-scale of the range the meter is set on. For example, if the DC value of the incoming signal is 1.25 V and the modulating AC signal amplitude is 50 mV, the frequency measurement error might increase or the measurement might freeze. This is due to the fact that, for a DC signal of 1.25V, the meter sets the range at 2.5 V and the AC amplitude of 50 mV is 2% of the full-scale range of 2.5V. The frequency measurement is based on the transitions the system “sees” in the input signal. If there is high noise in the input signal, the measurement might be inadvertently affected because the noise transitions would appear as being valid transitions. Also, as the input signal transitions become “softer”, i.e. the modulation signal is not a square but a sine wave, as the frequency decreases below 50 Hz, the system might consider that the input signal is DC and the measurement stops.

The frequency measurement is always available and a value is displayed at all times independent of the Mode. This being the case, it is up to the user to assess whether the frequency measurement makes sense or not for that particular measurement.

For example: in CW Continuous Mode, with the 5Hz filter on, the AC signal will be negligible. However, the meter might see some small transitions coming from noise and will display a value for the frequency. Obviously this displayed value should be ignored for this case. The Analog filter does not apply to the frequency measurement.

Below the specified minimum frequency value the measurement might skip or even freeze. This is normal, because the input signal approaches a frequency that can be perceived as DC by the system.

5.10 RMS Measurements

This section describes the procedure for making a basic signal RMS (Root Mean Square) measurement while properly removing the influence of ambient light and other drift effects. The 1935/2935 Series begins and ends the signal RMS every second.

- With a 918D or 818P Detector connected to the meter, turn the meter on. Set the Mode to RMS. Set the Range to Auto and press the Lambda (λ) key to set the measurement wavelength to the desired value.
- Cover or otherwise block the light source being measured, turn Zero on. Immediately upon entering the RMS mode, the meter will begin to acquire and calculate RMS value of the data. The display value may reflect the RMS of noise due to ambient temperature fluctuations (when using the 818P detectors) or light fluctuations (when using the 918D detectors).
- Uncover or trigger the source. The displayed value should now reflect the detector signal RMS value.
- The RMS value is calculated based on data acquired over a one second time period. The formula used to calculate the RMS value is given below:

$$y = \sqrt{\frac{\sum_{i=0}^n x_i^2}{n}}$$

Where x_i is the signal measured, n is the number of samples acquired over a one second period, and y is the RMS value.

NOTE

This process assumes that ambient signals are not changing between the moments when the user zeros the display and when the measurement is made.

6 Software Application

6.1 Overview

The 1935/2935 Series have a USB connector on the back of the unit that is used to connect to a computer for use with this application. (RS-232 connection for this application is not supported.)

Provided on the CD that comes with the unit is an installation for this software application, it communicates with the 1935/2935 Series using the USB port. The installation installs the USB drivers that are required to use USB communication.

The design of the software is to allow the user to remotely control basic functions of the instrument.

6.2 Connection

Start the application, which will detect and connect the attached power meter.

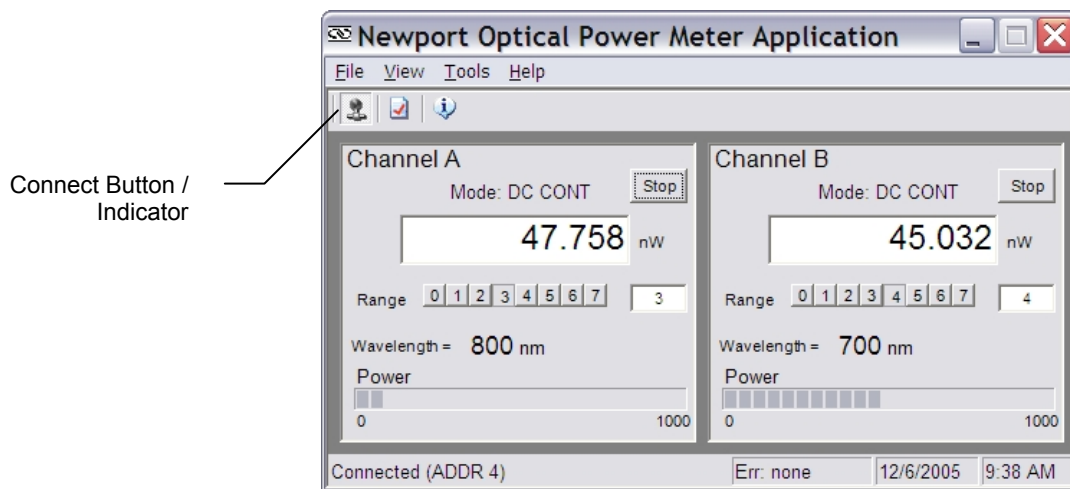

Figure 62 Application front panel

6.3 General Usage

This software application allows the user to setup and monitor the instrument remotely.

The controls on the instrument are available in the software in a very easy to read and change format.

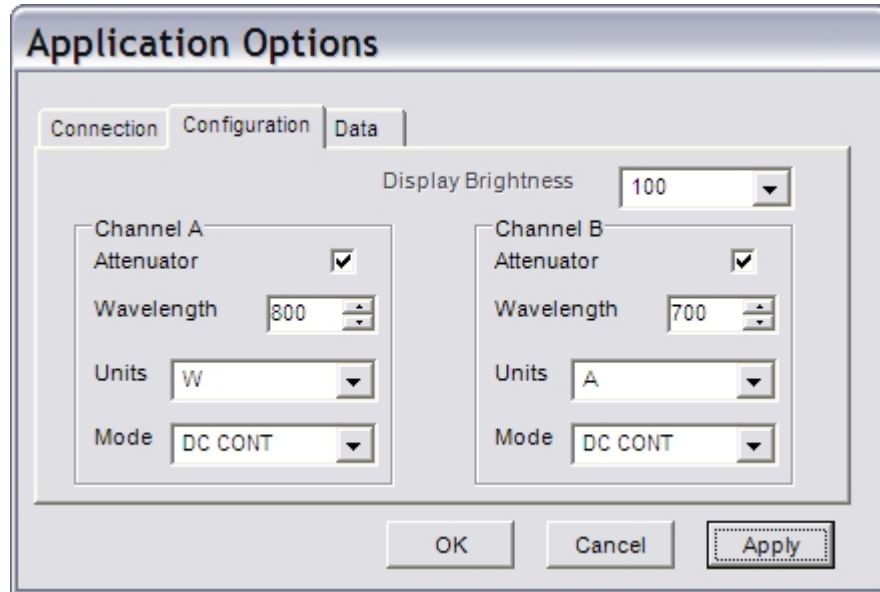

Figure 63 Application Advanced Options (Configuration Tab)

The application is designed to have menus similar to standard Windows applications like MS Word, to ease usability.

6.4 Menu Structure

To Exit the application go to the File menu and select Exit.

The Edit/Advanced Options menu has additional property settings, including channel settings and data logging options.

The Help/About will show information about the application, including firmware version when an instrument is connected and communicating.

7 Computer Interfacing

7.1 General Guidelines

The 1935/2935-C Series power meters have two computer interface ports: USB and RS-232. These communication interfaces can be used to send commands to the power meter from a host PC. The commands supported by the power meter can be divided into the following two categories: commands that cause the power meter to take a desired action, and commands (queries) that return a stored value or state of the power meter.

Query commands are always terminated by a question mark (?). It is recommended that when a query command is sent, the response to that command from the power meter be read before issuing any other command.

Set commands, on the other hand, are used to configure/setup the power meter for a desired mode of operation. These commands take at least one parameter. The subsequent sections in this chapter detail the RS-232 and USB communication protocols supported by the power meter.

7.2 Computer Interface Terminology

Listed below are the key abbreviations and concepts used in the command reference section (Section 8) of this manual.

7.2.1 <...> Delimiting Punctuation

For the purposes of this manual, any string enclosed by <...> is considered to be a command, a string or numerical argument. The punctuation <...> is used to symbolize the typographic limits of the command, string or argument in question.

7.2.2 <CR> Carriage Return

The ASCII encoded byte 13 in decimal. (0D hex)

7.2.3 <LF> Line Feed

The ASCII encoded byte 10 in decimal. (0A hex)

7.2.4 (;) Semicolons

Semicolons are used to separate commands within a single transmission (concatenation).

7.2.5 <number> Numerical Types

Numerical parameters are passed and returned as the actual ASCII characters in the string representation of the number. See section 11.2 for more detailed information.

7.2.6 <string> String Types

See the section 11.1 for a detailed description of <string>.

7.2.7 Command Termination

When the power meter receives a command from the RS-232 port, it interprets a <CR> in the command string as the command terminator. USB does not need a termination character.

7.2.8 Response Termination

RS-232 responses from the power meter are terminated by a <CR><LF> sequence.

7.3 Entering Remote Computer Interface Mode

When the power meter receives a command through either USB or RS-232 communication interface, it will automatically go into remote interface mode. In this mode of operation, users will not be able to make any operational changes to the power meter through its front panel. They will only be able to navigate through the various menus to read/verify the meter's settings.

In order to put the power meter back in a state where operational changes can be made locally, users may send either a "LOCAL" command through either USB or RS-232 interface or navigate to the "System Setup" menu and press the "LOCAL" soft key.

7.4 RS-232C Communication

Before communicating with the 1935/2935-C series power meters through the RS-232 port, proper cable connections must be made. Figure 32 shows the cable connection for communicating with the power meter over RS-232 interface. (Straight-through cable)

Once cable connections are made, the baud rate and echo mode need to be set. The baud rate, parity, data bit, and stop bits are fixed at:

Baud rate:	38400 bits/sec
Parity:	No parity
Data bits:	8 data bits
Stop bits:	1 stop bit

RS-232 communication with the 1935/2935-C series power meters can be performed with either echo ON or OFF. When the echo mode is enabled, the power meter generates a '>' prompt for every new line and all characters sent to the power meter are echoed back over the interface. As the user is entering commands the line may be edited by using the backspace key (sending an

ASCII decimal 08 code). This mode is especially useful when a simple terminal application is used to communicate with the power meter.

When echo mode is disabled (normal mode) the power meter does not generate a prompt or echo character back over the interface. This is the default state of the echo mode.

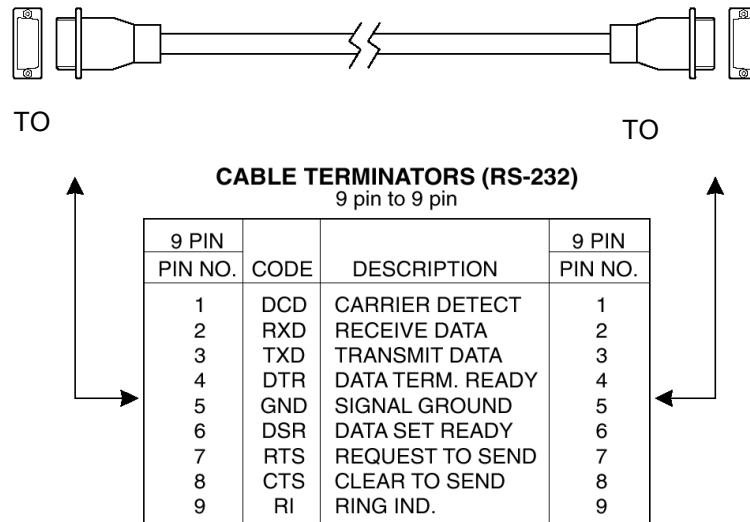

Figure 64 RS-232 9 Pin to 9Pin Cable Connections. Cable terminators (RS-232)

7.4.1 Setting Echo Mode From the Keypad

The echo mode can be turned ON/OFF from within the menu structure.

7.4.2 Setting Echo Mode via Remote Interface

To set the echo mode use the "ECHO" command. Use the "ECHO?" to see if the echo mode is enabled or disabled.

7.4.3 Setting the USB Address

The USB Address can be set remotely with the "ADDRess" command.

7.5 USB Communication

The instrument is designed to communicate with standard USB interfaces. When the instrument is first connected to a PC, the user will be prompted by the computer to install software drivers. These drivers are included in the software CD that accompanies the power meter. Communication can be done through this interface by using the application contained in the CD or by developing software in the user's preferred programming language. The software CD contains drivers and example programs in the following programming languages: LabVIEW, Visual Basic, and Visual C++.

This page is intentionally left blank

8 Communication Command Reference

8.1 Model 1935/2935 Series Remote Interface Commands

A complete listing of the commands supported by 1935/2935-C series power meters is provided below.

8.2 Command Overview

There are two types of commands: commands that cause the power meter to take a desired action, and queries that return a stored value or state of the power meter. Queries must end with a question mark (?), while commands may require parameter(s) to follow:

PM:Lambda 810

For example, the value “810” in the command **PM:Lambda 810** sets the wavelength for the currently selected channel to 810. The table below summarizes all the commands and queries supported by the 1935/2935-C series power meters. The command/query MUST contain all of the letters, which are shown in upper case in this table. The lower case letters shown with the commands are optional, and may be used for clarity. If any of the optional letters are used, then all of the optional letters are now required for the current command.

The commands may be sent to the instrument in either upper or lower case or in any combination. For example, the following commands are equal:

PM:Lambda 810

PM:L 810

pm:L 810

Pm:L 810

COMMAND EXECUTION:

The controller interprets the commands in the order they are received and execute them sequentially. If a set of commands have to be executed closer to each other, these commands can be sent to the controller simultaneously by creating a command string with semicolon (;) used as a command separator. The command string length should not exceed 50 characters. In the example shown below, a command string was created with semicolon

separating 5 queries. The controller responds to this command string with a response that has 5 values using a comma (,) as a separator.

COMMAND STRING:

PM:P?;PM:ATT?;PM:L?;ERR?

INSTRUMENT RESPONSE:

1.2450,1,810,0

8.2.1 Activate a Specific Channel

The command set of the power meter, by default, operates on channel A. In case of 2935-C power meter where there are 2 channels, the users can send commands for channel B after selecting this channel through “PM:CHANnel” command. Once a desired channel is selected using this command, all subsequent commands sent to the power meter will be addressed to that channel until it is changed again. The power meter defaults to channel “A” following a reset.

Note that the channel selected is specific to the communication interface over which the PM:CHANnel command was issued. For instance, if “PM:CHANnel 1” command was issued over RS-232 interface and “PM:CHANnel 2” command was issued over USB interface, all subsequent commands issued through RS-232 and USB interfaces will be addressed to channels A and B respectively.

Some commands do not apply to a particular channel, such as “BEEP”. The behavior of these commands is independent of the channel currently selected.

8.3 Command Description

8.3.1 Command Glossary

Root level Commands/Queries Summary

Name	Number of Parameters	Function	Page No.
*IDN?	NONE	Identification query	79
ADDRess	1	Sets the instrument’s USB address	80
ADDRess?	NONE	Returns the instrument’s USB address	80
BEEP	1	Turns the beeper on or off, or beeps once.	80
BEEP?	NONE	Returns the status of the beeper.	81
ERRors?	NONE	Returns errors generated since the last query.	81
ERRSTR?	NONE	Returns errors and their corresponding error text generated since the last query.	81

Table 2 Root level Commands/Queries Summary

Tree Level Commands/Queries Summary

Name	Number of Parameters	Function	Page No.
DISP:BRIGhT	1	Sets the backlight level of the display and the keypad	78
DISP:BRIGhT?	NONE	Returns the backlight level of the display and the keypad	78
DISP:SCReen	1	Switches to the n - screen display.	79
DISP:SCReen?	NONE	Returns displayed screen number, 0 – n/a screen number, 1 – Main, etc.	79
PM:ANALOG:OUT	1	Sets the analog output range to the desired level	82
PM:ANALOG:OUT?	NONE	Returns the analog output range	82
PM:ATT	1	Selects if the attenuator's calibration data is included for power calculation.	82
PM:ATT?	NONE	Returns setting if attenuator data should or should not be used when calibrating the power meter.	82
PM:ATTsN?	NONE	Gets the attenuator serial number.	83
PM:AUTO	1	Sets the power meter ranging to manual or automatic.	83
PM:AUTO?	NONE	Returns 1 if automatic power meter ranging is selected.	83
PM:CALDATE?	NONE	Returns the calibration date of the detector.	84
PM:CALTEMP?	NONE	Returns the temperature at which the calibration was performed.	84
PM:CHANnel	1	Selects the power meter channel to display and control.	84
PM:CHANnel?	NONE	Returns the power meter channel currently selected.	84
PM:DETMODEL?	NONE	Returns the model number of the detector.	85
PM:DETSN?	NONE	Returns the serial number of the detector.	85
PM:DS:BUFFer	1	Set data store behavior select.	85
PM:DS:BUFFer?	NONE	Returns data store behavior select.	86
PM:DS:CLear	NONE	Clear data store.	86
PM:DS:Count?	NONE	Returns data store count of items stored.	86
PM:DS:ENable	1	Set data store enable.	86
PM:DS:ENable?	NONE	Returns data store enable.	87
PM:DS:GET?	1	Returns data store data. {1,1-10,-5,+5} – value, range, oldest 5, newest 5	87
PM:DS:INTerval	1	Set data store interval.	87
PM:DS:INTerval?	NONE	Returns data store interval.	88
PM:DS:SAVEBUFER	1	Saves the data store buffer to a WinCE compatible USB flash disk	87
PM:DS:SIZE	1	Sets the size of the Data Store buffer	88
PM:DS:SIZE?	NONE	Returns the sizes of the Data Store buffer	89
PM:DS:UNITs?	NONE	Returns data store units.	89
PM:FILTer	1	Selects the filtering operation: no filtering, analog filter, digital filter, or analog and digital.	89
PM:FILTer?	NONE	Returns the filtering operation: no filtering, analog filter, digital filter, or analog and digital.	90
PM: FREQUency?	NONE	Returns the measured frequency value	90
PM:Lambda	1	Sets the wavelength for use when calculating power.	90
PM:Lambda?	NONE	Gets the selected wavelength in nanometers.	91
PM:MAX:Lambda?	NONE	Returns the longest calibrated wavelength in nanometers.	91
PM:MAX:Power?	NONE	Returns current range's maximum readable power.	91
PM:MIN:Lambda?	NONE	Returns the shortest calibrated wavelength in nanometers.	91
PM:MODE	1	Acquisition mode select	91
PM:MODE?	NONE	Returns the currently selected acquisition mode.	92
PM:Power?	NONE	Returns the power in the selected units.	92
PM:PWS?	NONE	Returns the power with status.	93
PM:RANge	1	Selects the gain stage when making readings with the detector head within a range from 0 to 6 (with zero being the highest).	93
PM:RANge?	NONE	Returns an integer indicating the current range.	93
PM:RESPOnsivity?	NONE	Gets the responsivity currently used for making power calculations.	94
PM:RUN	1	Disables or enables the acquisition of data.	94
PM:RUN?	NONE	Returns the present acquisition mode.	94

Name	Number of Parameters	Function	Page No.
PM:STAT:MAX?	NONE	Returns statistics buffer maximum value.	95
PM:STAT:MEAN?	NONE	Returns statistics buffer mean value.	95
PM:STAT:MIN?	NONE	Returns statistics buffer minimum value.	95
PM:STAT:MAXMIN?	NONE	Returns statistics buffer maximum-minimum value.	95
PM:STAT:SDEVIation?	NONE	Returns statistics buffer standard deviation value.	96
PM:Temp?	NONE	Returns the 918 detector's temperature in degrees Celsius.	96
PM:TRIG:EXTErnal	1	Set external trigger enable.	96
PM:TRIG:EXTErnal?	NONE	Returns external trigger enable.	96
PM:TRIG:EDGE	1	Set external trigger edge select.	97
PM:TRIG:EDGE?	NONE	Returns external trigger edge select.	97
PM:TRIG:HOLDoff	1	Set external trigger holdoff time.	98
PM:TRIG:HOLDoff?	NONE	Returns external trigger holdoff time.	98
PM:TRIG:START	1	Set the optional start event	98
PM:TRIG:START?	NONE	Returns optional start event	99
PM:TRIG:STOP	1	Set the optional stop event	99
PM:TRIG:STOP?	NONE	Returns optional start event	99
PM:TRIG:STATE	1	Set the trigger state	100
PM:TRIG:STATE?	NONE	Returns the trigger state	100
PM:TRIG:VALUE	1	Set the measurement level for trigger stop condition	100
PM:TRIG:VALUE?	NONE	Returns the measurement set level for trigger stop condition	101
PM:TRIG:TIME	1	Set the time duration for trigger stop condition	101
PM:TRIG:TIME?	NONE	Returns the time duration for trigger stop condition	101
PM:UNITs	1	Selects the units for readings.	101
PM:UNITs?	NONE	Returns an integer indicating the selected units.	102
PM:REF:VALue	1	Sets the user reference value for use in relative or dB readings.	102
PM:REF:VALue?	NONE	Returns the user reference value.	102
PM:REF:STOre	NONE	Sets the user reference value for use in relative or dB readings as the present reading.	103
PM:ZEROSTOre	NONE	Sets the zeroing value with the present reading.	103
PM:ZEROVALue	1	Sets the zeroing value.	103
PM:ZEROVALue?	NONE	Gets the zeroing value.	104
TEC:T?	NONE	Returns TEC measured temperature.	104

Table 3 Tree Level Commands/Queries Summary

8.3.2 Display Commands

8.3.2.1 DISP:BRIGHT

Description Display brightness command

Syntax **BRIGHT** *brightness*

Remarks The **BRIGHT** command controls the brightness of the instrument display.

Argument	Type	Description
<i>Brightness</i>	int	Brightness, in levels from 0 to 7

Related Commands: **DISP:BRIGHT?**

8.3.2.2 DISP:BRIGHT?

Description Display brightness query

Syntax **DISP:BRIGHT?**

Remarks The **BRIGHT?** query returns the display brightness setting.

Response	Type	Description
<i>Brightness</i>	int	Display brightness, in levels from 0 to 7

Related Commands: DISP:BRIGHT

8.3.2.3 DISP:SCReen

Description Set current instrument screen to display

Syntax DISP:SCREEN *ScreenIndex*

Remarks The **BRIGHT** command sets the displayed screen.

Argument	Type	Description
-----------------	-------------	--------------------

<i>ScreenIndex</i>	int	Index of screen
--------------------	-----	-----------------

Related Commands: DISP:BRIGHT?

8.3.2.4 DISP:SCReen?

Description Instrument displayed screen query

Syntax DISP:SCReen?

Remarks The **DISP:SCReen?** query returns the displayed screen.

Response	Type	Description
-----------------	-------------	--------------------

<i>ScreenIndex</i>	int	Index of screen
--------------------	-----	-----------------

Related Commands: DISP:BRIGHT

8.3.3 Power Meter Commands

8.3.3.1 *IDN?

Description Identification Query

Syntax *IDN?

Parameters None

Function

Remarks This query will cause the power meter to return an identification string.

Model name	Firmware version #	Firmware date	Controller Serial #
NEWPORT XXXX	vYYY	mm/dd/yy	SNZZZZ

Examples:

NEWPORT 1935-C v1.0.0 12/12/05 SN0001

NEWPORT 2935-C v1.0.0 12/12/05 SN0001

8.3.3.2**ADDRESS****Description** USB address command.**Syntax** **ADDRESS** value**Remarks** The **ADDRESS** command sets the power meter USB address. After changing USB address, the communication with the power meter has to be re-initialized.

Argument	Value	Description
<i>Value</i>	0	<i>Reserved</i>
	1 to 31	<i>Valid USB address range</i>

Related Commands: **ADDRESS?****8.3.3.3****ADDRESS?****Description** USB address query.**Syntax** **ADDRESS?****Remarks** The **ADDRESS** query returns the power meter's USB address.

Response	Value	Description
<i>address</i>	0	<i>Reserved</i>
	1 to 31	<i>Valid USB address range</i>

Related Commands: **ADDRESS****8.3.3.4****BEEP****Description** Beep command**Syntax** **BEEP** *beep set***Remarks** The **BEEP** command controls the power meter's beeper. The beeper can be used to signal error or warning conditions.

Response	Value	Description
<i>beep set</i>	0	Disable beeper
	1	Enable beeper
	2	Beep for 100 ms

Note: The beeper is enabled at power on.

Related Commands: **BEEP?**

8.3.3.5**BEEP?****Description** Beep query**Syntax** **BEEP?****Remarks** The **BEEP?** query returns the enable status of the power meter's beeper.

Response	Value	Description
<i>beep set</i>	0	Beeper disabled
	1	Beeper enabled

Related Commands: **BEEP****8.3.3.6****ERRors?****Description** Error query**Syntax** **ERRors?****Remarks** The **ERRors?** query returns a single error number that has occurred since the last query. This error is indicated by a number that corresponds to the type of error that occurred. This command also clears the read error from the Error buffer.

Response	Type	Description
<i>Error code</i>	int	Error code number per Appendix B, 0 if no errors

Related Commands: **ERRSTR?****8.3.3.7****ERRSTR?****Description** Error string query**Syntax** **ERRSTR?****Remarks** The **ERRSTR?** query returns a single error number along with the corresponding error text string that have occurred since the last error query.

Response	Type	Description
<i>Error code,</i>	string	Error code number and text for error code as " <i>text</i> " per Appendix B, 0 if no errors

Related Commands: **ERRors?**

8.3.3.8 PM:ANALOG:OUT**Description** Analog output range select command**Syntax** **PM:ANALOG:OUT** *range***Remarks** The **PM:ANALOG:OUT** command selects the analog output range.

Argument	Value	Max. Output
<i>Range</i>	0	1 V
	1	2 V
	2	5 V
	3	10 V

Related Commands: **PM:ANALOG:OUT?****8.3.3.9 PM:ANALOG:OUT?****Description** Analog output range query**Syntax** **PM:ANALOG:OUT?****Remarks** The **PM:ANALOG:OUT?** query returns an integer indicating the present analog output range.

Response	Value	Max. Output
<i>Range</i>	0	1 V
	1	2 V
	2	5 V
	3	10 V

Related Commands: **PM:ANALOG:OUT****8.3.3.10 PM:ATT****Description** Attenuator enable command**Syntax** **PM:ATT** *enable***Remarks** Indicates whether or not the attenuator for the 818 Series power detector is on the detector.

Argument	Type	Description
<i>Enable</i>	int	Enable use of detector responsivity with attenuator available in the calibration module for 818 detectors.

Related Commands: **PM:ATT?****8.3.3.11 PM:ATT?****Description** Attenuator enable query

Syntax	PM:ATT?	
Remarks	The PM:ATT? query returns 1 when using attenuator calibration, 0 when calculating power without attenuator data.	
Response	Value	Description
attenuator	0	Calibrating power without attenuator
	1	Calibrating power using attenuator
Related Commands: PM:ATT		

8.3.3.12**PM:ATTSN?**

Description	Attenuator serial number query	
Syntax	PM:ATTSN?	
Remarks	The PM:ATTSN? query returns the serial number of the attenuator. When no detector is found the power meter responds with "no detector".	
Response	Type	Description
serial number	string	Serial number of the attenuator
Related Commands: PM:DETMODEL?, PM:DETSN?		

8.3.3.13**PM:AUTO**

Description	Auto range enable command	
Syntax	PM:AUTO <i>mode</i>	
Remarks	The PM:AUTO command sets the power ranging to either manual or automatic.	
Argument	Value	Description
<i>mode</i>	0	Manual power meter ranging
	1	Automatic power meter ranging
Related Commands: PM:AUTO?, PM:RANGe		

8.3.3.14**PM:AUTO?**

Description	Auto range mode query	
Syntax	PM:AUTO?	
Remarks	The PM:AUTO? query returns a value to indicate if auto ranging is enabled or not.	
Response	Value	Description
<i>mode</i>	0	Manual power meter ranging
	1	Automatic power meter ranging
Related Commands: PM:AUTO, PM:RANG		

8.3.3.15 PM:CALDATE?**Description** Detector calibration date query**Syntax** **PM:CALDATE?****Remarks** The **PM:CALDATE?** query returns the calibration date of the detector.*For example:* 21JUN1999.

Response	Type	Description
<i>Date</i>	string	DDMMMYYYYY

8.3.3.16 PM:CALTEMP?**Description** Temperature at which detector was calibrated query**Syntax** **PM:CALTEMP?****Remarks** The **PM:CALTEMP?** query returns the temperature (degrees Celsius) at which the detector was calibrated. When no detector is present, "no detector" is returned.

Response	Type	Description
<i>temperature</i>	float	Returns the temperature at which the detector was calibrated.

8.3.3.17 PM:CHANnel**Description** Select power meter channel**Syntax** **PM:CHAN** *channel***Remarks** The **PM:CHAN** command selects the power meter channel for control.

Argument	Type	Description
<i>Channel</i>	int	Power meter channel

Related Commands: **PM:CHAN?****8.3.3.18 PM:CHANnel?****Description** Power meter channel query**Syntax** **PM:CHAN?****Remarks** The **PM:CHAN?** query returns the power meter channel currently selected.

Response	Value	Description
channel	int	Currently selected power meter channel 1

Related Commands: **PM:CHAN**

8.3.3.19 **PM:DETMODEL?**

Description Detector model query

Syntax **PM:DETMODEL?**

Remarks The **PM:DETMODEL?** query returns the model number of the detector.

For example: 818-SL.

Response	Type	Description
model	string	Detector model number

8.3.3.20 **PM:DETSN?**

Description Detector serial number query

Syntax **PM:DETSN?**

Remarks The **PM:DETSN?** query returns the serial number of the detector.

For example: 0001

Response	Type	Description
serial number	string	Detector serial number

8.3.3.21 **PM:DS:BUfFer**

Description Data Store buffer behavior selection

Syntax **PM:DS:BUfFer** *behavior*

Remarks The **PM:DS:BUfFer** command selects the behavior mode for control of the Data Store buffer.

Argument	Value	Description
<i>Mode</i>	0	Fixed Size
	1	Ring Buffer

The behavior of the ring buffer is to allow continual data collection after the buffer is full where the oldest values will be overwritten when new measurements are taken.

Related Commands: **PM:DS:BUfFer?**

8.3.3.22 PM:DS:BUfFer?

Description Data Store buffer behavior selection query

Syntax **PM:DS:BUfFer?**

Remarks The **PM:DS:BUfFer?** query returns the value of the Data Store buffer behavior.

Argument	Type	Description
<i>Behavior</i>	int	See PM:DS:BUfFer for a definition of the behavior status.

8.3.3.23 PM:DS:CLear

Description Clear the Data Store of all data

Syntax **PM:DS:CLear**

Remarks The **PM:DS:CLear** command resets the data store to be empty with no values.

Argument	Type	Description
none	-	

8.3.3.24 PM:DS: Count?

Description Data Store data item count query

Syntax **PM:DS:Count?**

Remarks The **PM:DS:Count?** query returns the number of measurements that have been collected in the Data Store.

Argument	Type	Description
<i>count</i>	int	The number of measurements that have been collected.

8.3.3.25 PM:DS:ENable

Description Enable Data Store Collection

Syntax **PM:DS:ENable** *enable*

Remarks The **PM:DS:ENable** enables or disables the collection of measurements in the Data Store.

Argument	Value	Description
<i>enable</i>	0	Disabled
	1	Enabled

Data will be collected after the **PM:DS:ENable** command has been called with a parameter of 1. Data collection will stop when the **PM:DS:ENable**

command has been called with a parameter of 0 or when a fixed size data buffer is full.

Related Commands: **PM:DS:ENable?**

8.3.3.26 **PM:DS:ENable?**

Description Enable Data Store Collection query

Syntax **PM:DS:ENable?**

Remarks The **PM:DS:ENable?** query returns the enabled status of the Data Store.

Argument	Type	Description
<i>enable</i>	int	See PM:DS:Enable for a description of the enable argument

8.3.3.27 **PM:DS:GET?**

Description Retrieve Data Store data query

Syntax **PM:DS:GET? *num***

Remarks The **PM:DS:GET?** command returns a number of measurements that have been collected in the Data Store.

Argument	Type	Description
<i>selection</i>	string	“1” – returns the single value specified “1-10” – returns values in the range from 1-10 “-5” – returns the oldest 5 values (same as 1-5) “+5” – returns the newest 5 values

Note: depending on the number of data points requested, there may be several read operations required on the USB or RS-232 computer interfaces.

8.3.3.28 **PM:DS:INTerval**

Description Data Store Interval Select

Syntax **PM:DS:INTerval <interval>**

Parameters

The parameter <interval> is of type <number> that is an integer. The parameter represents the interval in milliseconds for storing one measurement in the data buffer.

Function

This command sets the interval in milliseconds to be used for data storing. For example if DSINT = 100 and DSSIZE = 100 it will take 100 x 100ms to fill the buffer.

Related Commands: **PM:DS:SIZE,PM:DS:SIZE?,PM:DS:INTerval?**

8.3.3.29 PM:DS:INTerval?**Description** Data Store Interval Query**Syntax** **PM:DS:INTerval?****Parameters** None**Function**

This query returns the interval in milliseconds currently used for data storing.

Related Commands: **PM:DS:SIZE,PM:DS:SIZE?,PM:DS:INTerval****8.3.3.30 PM:DS:SAVEBUFFER****Description** Save the current Data Store data to a file**Syntax** **PM:DS:SAVEBUFFER** *filename***Remarks** The **PM:DS:SAVEBUFFER** command saves the current user Data Store for the current channel to a file on the WinCE compatible USB Flash Disk plugged into the USB Host port on the front of the Power Meter.

Argument	Type	Description
<i>Filename</i>	<i>string</i>	The filename that will be created or overwritten on the USB Flash Disk containing the measurements for the current channel stored in the Data Store.

8.3.3.31 PM:DS:SIZE**Description** Size of the Data Store query**Syntax** **PM:DS:SIZE** <size>**Parameters**

The parameter <size> is of type <integer> in the range 1 to 250000. The parameter represents the size of the data buffer to be used for data storing.

Function

This command sets the size of the buffer for the currently selected channel used for data storing.

NOTE

The data buffer is cleared automatically when this command is used and all previously stored data will be gone.

Related Commands: **PM:DS:SIZE?,PM:DS:INTerval,PM:DS:INTerval?**

8.3.3.32 PM:DS:SIZE?**Description** Data Store Buffer Size Query**Syntax** **PM:DS:SIZE?****Parameters** None**Function** This query returns the data store buffer size for the currently selected channel.**Returns** <size> is of type <number> and represents an integer of the range 1 to 250000.**Related Commands:** **PM:DS:SIZE,PM:DS:INTerval,PM:DS:INTerval?****8.3.3.33 PM:DS:UNITs?****Description** Data store units query**Syntax** **PM:DS:UNITs?****Remarks** The **PM:DS:UNITs?** query returns an integer indicating the units selected.

Response	Value	Description
<i>units</i>	0	Amps
	1	Volts
	2	Watts
	3	Watts/cm ²
	4	Joules
	5	Joules/cm ²
	6	dBm

Related Commands: **PM:UNITS,PM:UNITS?****8.3.3.34 PM:FILTer****Description** Filter select command**Syntax** **PM:FILT** *filter type***Remarks** The **PM:FILT** command select the filtering operation to be performed on power readings.

Argument	Value	Description
<i>Filter type</i>	0	No filtering
	1	Analog filter
	2	Digital filter
	3	Analog and Digital filter

Related Commands: **PM:FILT?**

8.3.3.35 PM:FILTer?**Description** Filter type query**Syntax** **PM:FILT?****Remarks** The **PM:FILT?** query returns an integer indicating the present filter mode.

Response	Value	Description
<i>Filter type</i>	0	No filtering
	1	Analog filter
	2	Digital filter
	3	Analog and Digital filter

Related Commands: **PM:FILT****8.3.3.36 PM:FREQuency?****Description** Measured frequency query**Syntax** **PM:FREQuency?****Remarks** The **PM:FREQuency?** query returns a value indicating the present measured frequency in Hertz.**8.3.3.37 PM:Lambda****Description** Wavelength set command**Syntax** **PM:Lambda** *value***Remarks** The **PM:Lambda** command selects the wavelength to use when calculating power. The value must fall within the calibrated wavelength of the detector.

Argument	Type	Description
<i>Value</i>	int	Wavelength in nanometers (nm)

Related Commands: **PM:Lambda?**, **PM:MAX:Lambda?**, **PM:MIN:Lambda?****8.3.3.38 PM:Lambda?****Description** Wavelength query**Syntax** **PM:Lambda?****Remarks** The **PM:Lambda?** query returns the selected wavelength in nanometers. This is the wavelength used to look up the responsivity from the calibration data.

Response	Type	Description
<i>Wavelength</i>	int	Wavelength in nanometers (nm)

Related Commands: PM:Lambda, PM:MAX:Lambda?, PM:MIN:Lambda?

8.3.3.39 PM:MAX:Lambda?

Description	Maximum wavelength query	
Syntax	PM:MAX:Lambda?	
Remarks	The PM:MAX:Lambda? query returns the longest calibrated wavelength in nanometers. If no detector is preset, the max lambda for the last read detector is returned.	
Response	Type	Description
<i>Wavelength</i>	int	Wavelength in nanometers (nm)

Related Commands: PM:MIN:Lambda?

8.3.3.40 PM:MAX:Power?

Description	Maximum power query	
Syntax	PM:MAX:Power?	
Remarks	The PM:MAX: Power? returns current range's maximum readable power.	
Response	Type	Description
<i>Power</i>	float	Power in Watts

8.3.3.41 PM:MIN:Lambda?

Description	Minimum wavelength query	
Syntax	PM:MIN:Lambda?	
Remarks	The PM:MIN:Lambda? query returns the shortest calibrated wavelength in nanometers. If no detector is preset,min lambda for the last read detector is returned.	
Response	Type	Description
<i>Wavelength</i>	int	Wavelength in nanometers (nm)

Related Commands: PM:MAX:Lambda?

8.3.3.42 PM:MODE

Description	Acquisition mode select
Syntax	PM:MODE <i>mode</i>

Remarks The **PM:MODE** command selects the acquisition mode for acquiring subsequent readings.

Argument	Value	Description
<i>Mode</i>	0	DC Continuous
	1	DC Single
	2	Integrate
	3	Peak-to-peak Continuous
	4	Peak-to-peak Single
	5	Pulse Continuous
	6	Pulse Single
	7	RMS

Related Commands: **PM:MODE?**

8.3.3.43 **PM:MODE?**

Description Acquisition mode query

Syntax **M:MODE?**

Remarks The **PM:MODE?** query returns an integer indicating the present acquisition mode.

Response	Value	Description
<i>Mode</i>	0	DC Continuous
	1	DC Single
	2	Integrate
	3	Peak-to-peak Continuous
	4	Peak-to-peak Single
	5	Pulse Continuous
	6	Pulse Single
	7	RMS

Related Commands: **PM:MODE**

8.3.3.44 **PM:Power?**

Description Power query

Syntax **PM:P?**

Remarks The **PM:P?** query returns the power in the selected units.

Response Type Description *power* exp Exponential form (i.e. 9.4689E-04)

Related Commands: PM:UNITS?, PM:PWS?**8.3.3.45****1.1.1.1 PM:PWS?**

Description Read with status query

Syntax **PM:PWS?**

Remarks The **PM:PWS?** query returns the status and values of the reading. The status should be used to validate the reading. The reading will be in units corresponding to the units field in the status word.

Response	Type	Description
<i>Power reading 1</i>	exp	Power in present units for channel 1
<i>Status 1</i>	int	A bitfield in hexadecimal defining the current channel status
<i>Power reading 2</i>	exp	Power in present units channel 2 (if present. 0.0 otherwise)
<i>Status 2</i>	int	A bitfield in hexadecimal defining the current channel status

NOTE: The bitfield is defined as follows:

Bits 9-7	Channel Units. See PM:UNITS?
Bits 6-4	Channel Range, See PM:RANge?
Bit 3	Detector Present
Bit 2	Channel range change status. Indicates if a measurement has been taken while the unit is ranging
Bit 1	Detector Saturated (reserved, follows bit 0)
Bit 0	Channel overrange. Indicates that the current measurement is overrange for the current channel range

Related Commands: PM:MODE?**8.3.3.46****PM:RANge**

Description Range select

Syntax **PM:RANge** *range*

Remarks The **PM:RANge** command selects the gain stage when making readings from the detector head. The range of this value depends on the detector being used.

Response	Type	Description
<i>range</i>	int	Values range from 0 to 5

Related Commands: PM:RANge?, PM:AUTO**8.3.3.47****PM:RANge?**

Description Range query

Syntax	PM:RANge?	
Remarks	The PM:RANge? query returns an integer that indicates the present range. The range of this value depends on the detector being used.	
Response	Value	Description
<i>range</i>	0	Values range from 0 to 5
Related Commands: PM:RANge , PM:AUTO		

8.3.3.48 PM:RESPonsivity?

Description	Responsivity query	
Syntax	PM:RESP?	
Remarks	The PM:RESP? query returns the responsivity currently used in making power calculations.	
Response	Type	Description
<i>Responsivity</i>	float	Power meter responsivity
Related Commands: PM:UNITS? , PM:PWS?		

8.3.3.49 PM:RUN

Description	Run command	
Syntax	PM:RUN <i>mode</i>	
Remarks	The PM:RUN command disables or enables the acquisition of data.	
Argument	Value	Description
<i>Mode</i>	0	Stop
	1	Run
Related Commands: PM:RUN? , PM:MODE?		

8.3.3.50 PM:RUN?

Description	Run query	
Syntax	PM:RUN?	
Remarks	The PM:RUN? query returns an integer indicating the present run mode.	
Response	Value	Description
<i>Mode</i>	0	Stopped
	1	Running
Related Commands: PM:RUN , PM:MODE?		

8.3.3.51 PM:STAT:MAX?

Description	Statistics Maximum Value Query
Syntax	PM:STAT:MAX?
Parameters	None
Function	This query returns the maximum value in the statistics buffer.
Returns	<max> <max>is of type <number>in exponent notation.

8.3.3.52 PM:STAT:MEAN?

Description	Statistics Mean Value Query
Syntax	PM:STAT:MEAN?
Parameters	None
Function	This query returns the mean or average of all the values in the statistics buffer.
Returns	<mean> <mean>is of type <number>in exponent notation.

8.3.3.53 PM:STAT:MIN?

Description	Statistics Minimum Value Query
Syntax	PM:STAT:MIN?
Parameters	None
Function	This query returns the minimum value in the statistics buffer.
Returns	<min> <min>is of type <number>in exponent notation.

8.3.3.54 PM:STAT:MAXMIN?

Description	Statistics Max-Min Query
Syntax	PM:STAT:MAXMIN?
Parameters	None
Function	This query returns the difference between the maximum and minimum readings in the statistics buffer.
Returns	<mxmn> <mxmn>is of type <number>in exponent notation.

8.3.3.55 PM:STAT:SDEVIation?**Description** Statistics Standard Deviation Query**Syntax** **PM:STAT:SDEVIation?****Parameters** None**Function** This query returns the standard deviation of the readings in the statistics buffer.**Returns** <stddev>
<stddev>is of type <number>in exponent notation.**8.3.3.56 PM:Temp?****Description** 918 detector temperature query**Syntax** **PM:Temp?****Remarks** The **PM:Temp?** query returns the 918 detector's temperature as a float in degrees Celsius.

Response	Type	Description
temp	float	Detector temperature in degrees Celsius (°C)

Related Commands: **PM:ATT?****8.3.3.57 PM:TRIG:EXTernal****Description** External Trigger Enable**Syntax** **PM:TRIG:EXTernal** <enable>**Parameters**

The parameter <state>is either 0, 1, 2, or 3. If <state>is 0 then the external trigger is disabled. If <state>is 1 then the external trigger is enabled on channel A. If <state>is 2 then the external trigger is enabled on channel B. If <state>is 3 then the external trigger is enabled on both channels.

Function

This command enables or disables the external trigger input on the back panel.

Related Commands: **PM:TRIG:EXTernal?****8.3.3.58 PM:TRIG:EXTernal?****Description** External Trigger Enable Query**Syntax** **PM:TRIG:EXTernal?**

Parameters None

Function

This query returns a value showing whether the external trigger input is enabled or disabled.

Returns <state>

<state> is of type <number> that represents the integer 0, if the external trigger input is disabled. If <state> is 1, 2, or 3, the external trigger is enabled on channel A, channel B, or both respectively.

Related Commands: **PM:TRIG:EXTernal,**

8.3.3.59 PM:TRIG:EDGE

Description External Trigger Edge Select

Syntax **PM:TRIG:EDGE** <edge>

Parameters

The parameter <edge> is either 0 or 1. If <edge> is 0 then the external trigger is defined as a falling edge. If <edge> is 1 then the external trigger is defined as a rising edge.

Function

This command defines whether the external trigger input on the back panel is falling edge or rising edge active.

Related Commands: **PM:TRIG:EXTernal, PM:TRIG:EXTernal?, PM:TRIG:EDGE?**

8.3.3.60 PM:TRIG:EDGE?

Description External Trigger Edge Query

Syntax **PM:TRIG:EDGE?**

Parameters None

Function

This query returns a value showing which external trigger edge is the active edge.

Returns <edge>

<edge> is of type <number> and represents 0, if the external trigger is defined as a falling edge, or 1, if the external trigger is defined as a rising edge.

Related Commands: **EXT PM:TRIG:EXTernal, PM:TRIG:EXTernal?, PM:TRIG:EDGE**

8.3.3.61 PM:TRIG:HOLDoff

Description External Trigger Holdoff Time Command

Syntax **PM:TRIG:HOLDoff** <time>

Parameters

The parameter <time> is of type <number> and is an integer from 0 to 1000. <time> is the delay in milliseconds for the trigger to take effect.

Function

This command sets the delay interval before the trigger takes effect.

Related Commands: **PM:TRIG:EXTernal**, **PM:TRIG:EXTernal?**, **PM:TRIG:HOLDoff?**

8.3.3.62 PM:TRIG:HOLDoff?

Description External Trigger Holdoff Time Query

Syntax **PM:TRIG:HOLDoff?**

Parameters None

Function

This query returns the delay in milliseconds before the trigger takes effect.

Related Commands: **PM:TRIG:EXTernal**, **PM:TRIG:EXTernal?**, **PM:TRIG:HOLDoff**

8.3.3.63 PM:TRIG:START

Description This command sets the optional start event.

Syntax **PM:TRIG:START** *option*

Parameters

The parameter <option> is of type <number> and is an integer from 0 to 3.

Argument	Value	Description
<i>option</i>	0	Continuous measurement
	1	Measurement starts when an external trigger occurs
	2	Measurement starts when a designated Soft key is pressed
	3	Measurement starts when PM:TRIG:STATE 1 command is issued.

Related Commands: **PM:TRIG:START?**

8.3.3.64 PM:TRIG:START?**Description** Trigger START Query**Syntax** **PM:TRIG:START?****Parameters** None**Function**

This query returns the TRIGGER START condition.

Related Commands: **PM:TRIG: START****8.3.3.65 PM:TRIG:STOP****Description** This command sets the optional stop event.**Syntax** **PM:TRIG:STOP** <option>**Parameters**

The parameter <option> is of type <number> and is an integer from 0 to 6.

Argument	Value	Description
<i>option</i>	0	The measurement never stops
	1	Measurement stops when an external trigger occurs
	2	Measurement stops when a designated Soft key is pressed
	3	Measurement stops when PM:TRIG:STATE 0 command is issued.
	4	Measurement stops when a pre-specified measurement level (PM:TRIG:VALUE) is reached
	5	Measurement stops when a pre-specified time interval (PM:TRIG:TIME) from TRIGGER START has been reached

Related Commands: **PM:TRIG: STOP?****8.3.3.66 PM:TRIG:STOP?****Description** Trigger STOP Query**Syntax** **PM:TRIG:STOP?****Parameters** None

Function

This query returns the TRIGGER STOP condition.

Related Commands: PM:TRIG: STOP

8.3.3.67 PM:TRIG:STATE

Description This command sets the trigger state

Syntax **PM:TRIG:STATE** <option>

Parameters

The parameter <option> is of type <number> and is an integer 0 or 1.

Argument	Value	Description
<i>option</i>	0	Trigger is armed. The system waits for a trigger start event to occur in order to make a measurement.
	1	System is triggered and at least one measurement occurred.

Related Commands: PM:TRIG: STATE?

8.3.3.68 PM:TRIG:STATE?

Description Trigger STATE Query

Syntax **PM:TRIG:STATE?**

Parameters None

Function

This query returns the TRIGGER STATE condition.

Related Commands: PM:TRIG: STATE

8.3.3.69 PM:TRIG:VALUE

Description This command sets the measurement level that indicates a trigger stop condition. The power meter will stop taking further measurements if a measurement taken exceeds the value specified by this command, and if trigger stop option is set to measurement level.

Syntax **PM:TRIG:VALUE** *value*

Parameters

The parameter <value> is of type <number>

Argument	Value	Description
<i>value</i>	float	Measurement level

Related Commands: PM:TRIG:STOP**8.3.3.70 PM:TRIG:VALUE?**

Description This command returns the measurement level that indicates a trigger stop condition.

Syntax **PM:TRIG:VALUE?**

Parameters None

Related Commands: PM:TRIG:STOP**8.3.3.71 PM:TRIG:TIME**

Description This command sets the time duration that indicates a trigger stop condition. The power meter will stop taking further measurements if the time from trigger start exceeds time duration specified by this command, and if trigger stop option is set to time.

Syntax **PM:TRIG:TIME** *value*

Parameters

The parameter <value> is of type <number>

Argument	Value	Description
<i>value</i>	int	Time (milli-seconds)

Related Commands: PM:TRIG:STOP**8.3.3.72 PM:TRIG:TIME?**

Description This command returns the time duration that indicates a trigger stop condition.

Syntax **PM:TRIG:TIME?**

Parameters None

Related Commands: PM:TRIG:STOP**8.3.3.73 PM:UNITS**

Description Units select

Syntax **PM:UNITS** *units*

Remarks The **PM:UNITS** command selects the units for readings.

Argument	Value	Description
<i>units</i>	0	Amps
	1	Volts
	2	Watts

3	Watts/cm ²
4	Joules
5	Joules/cm ²
6	dBm

Related Commands: PM:MODE?

8.3.3.74 PM:UNITs?

Description Units query

Syntax **PM:UNITs?**

Remarks The **PM:UNITs?** query returns an integer indicating the units selected.

Response	Value	Description
<i>units</i>	0	Amps
	1	Volts
	2	Watts
	3	Watts/cm ²
	4	Joules
	5	Joules/cm ²
	6	dBm

Related Commands: PM:UNITs

8.3.3.75 PM:REF:VALue

Description Reference Value Define

Syntax **PM:REF:VALue <val>**

Parameters

The parameter <val> is of type <number>.

Function

This command provides a means of directly storing a reference value to be used in linear and logarithmic (dB) relative measurements. The units of this value are the current units being used by the instrument.

Related Commands: PM:REF:STOre, PM:REF:VALue?

8.3.3.76 PM:REF:VALue?

Description Reference Value Query

Syntax **PM:REF:VALue?**

Parameters None

Function

This query returns the user defined reference value. The units of this value are the current units being used by the instrument.

Returns <refval>

<refval> is of type <number>

Related Commands: PM:REF:STOre,PM:REF:VALue

8.3.3.77 PM:REF:STOre

Description Reference Value Store

Syntax PM:REF:STOre

Parameters None

Function

This command takes the latest reading and stores it as a reference reading to be used when making relative linear and dB measurements. The units of this value are the current units being used by the instrument.

Related Commands: PM:REF:VALue,PM:REF:VALue?

8.3.3.78 PM:ZEROSTOre

Description Zero value set command

Syntax PM:ZEROSTO

Remarks The PM:ZEROSTO command sets the zeroing value with the present reading.

Argument	Type	Description
----------	------	-------------

none	-	
------	---	--

Related Commands: PM:ZERO, PM:ZEROVAL?

8.3.3.79 PM:ZEROVALue

Description Zero value set command

Syntax PM:ZEROVAL *value*

Remarks The PM:ZEROVAL command sets the zeroing value. When enabled, zeroing subtracts the stored zero value from readings before making measurement calculations.

Argument	Type	Description
----------	------	-------------

<i>Value</i>	float	Zeroing value
--------------	-------	---------------

Related Commands: PM:ZERO?, PM:ZEROSTO

8.3.3.80 PM:ZEROVALue?**Description** Zero value query**Syntax** **PM:ZEROVAL?****Remarks** The **PM:ZEROVAL?** query returns the zero value.

Response	Type	Description
<i>value</i>	float	Zero exponent

Related Commands: **PM:ZEROVAL**, **PM:ZERO?****8.3.4 TEC Commands (1935T-C/2935T-C only)****8.3.4.1 TEC:T?****Description** 918 detector temperature query**Syntax** **TEC:Temp?****Remarks** The **TEC:Temp?** query returns the 918 detector's temperature as a float in degrees Celsius.

Response	Type	Description
Temp	float	Detector temperature in degrees Celsius (°C)

Related Commands: **PM:ATT?**

9 Principles Of Operation

9.1 Introduction

The 1935/2935 Series Power Meters electronics adapt to a number of signal measurement tasks: DC current or voltage, AC peak-to-peak current or pulse voltage, or integrated DC current or voltage signals. This versatility is required to handle the various signals that Newport's **Low Power, High-Power, Energy** and other detector families generate. These detector families are based on semiconductor, thermopile, pyroelectric as well as radiometric, photometric and other detectors. The detector data is introduced to the 1935/2935 Series by way of a calibration module specific to the detector in use. At power up (and RESET), the 1935/2935 downloads information about the detector from the calibration module or the detector internal memory. Based on the calibration module preprogrammed data, the meter learns the set of operating states available to the detector. The user then selects among the available operating states when using the meter. Front panel control and the operating states of the Model 1935/2935 Series are discussed in Sections 3.

9.2 Analog Signal Flow

The detector signals can follow many different paths through the 1935/2935 Series input amplifier chain. A block diagram of analog signal flow is shown in Figure 22. The actual flow path depends upon the detector type and the mode of measurement.

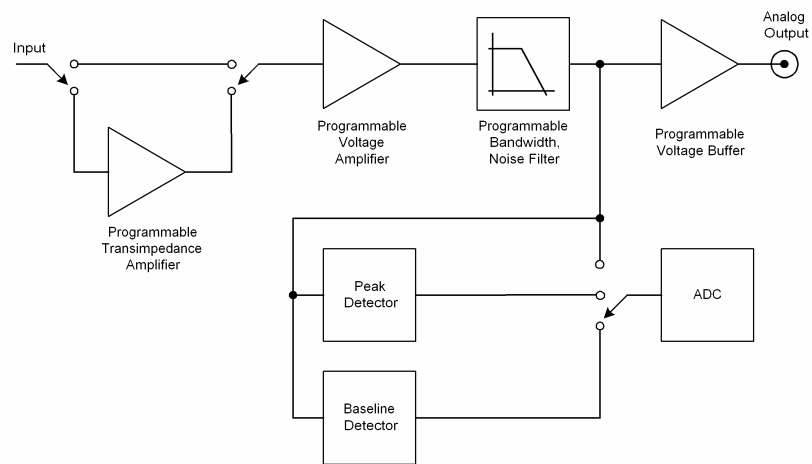

Figure 65 Model 1935/2935 Series Analog Signal Flow Diagram

The analog signal flow path is primarily determined by the responsivity units of the detector. The numerator of these units indicates how the meter must be configured in order to obtain a calibrated optical measurement. Analog signal flow is independent of whether single or continuous measurements are made.

Responsivity units and signal flows for the various detector families are listed in Table 4.

Detector Family	Resp. Units	Mode	Amplifier Path	Peak-Baseline
Low-Power	A / W	DC	I	No
Low-Power	A / W	Peak-Peak	I	No
Low-Power	A / W	Integral	I	No
High-Power	V / W	DC	V	No
High-Power	V / W	Integral	V	No
Energy	V / J	Pulse	V	Yes

Table 4 Analog Signal Flow Paths.

9.3 Digitized Signal Flow

An analog-to-digital converter captures the input signal. The input signal has the units of current or voltage depending upon how the input amplifier chain was configured. Note: In this manual the digitized signal may be referred as *sampled signal* or *samples*.

This digitized signal moves through a number of process steps that may or may not alter the digitized value depending upon the operating state of the meter. Each of these possible-processing steps is discussed further.

Digital Filter

If the digital filter annunciator Dig or Digital is on, Section 2.3.4, the filter output is the average of the most recent 10, 100, 1000, 10000 samples. The number of samples is selectable by the user with the Filter menu. Also, The user can change the number of samples. When less than the selected number of samples has been acquired since the last reset of the digital filter, the output is the average of all the values received. The digital filter is reset when the Model 1935/2935 is turned on and whenever the UNITS or the range changes or when the MODE of operation changes.

NOTE

When using the digital filter in CW Single acquisition mode, each measurement is the average of the last 10, 100, 1000, 10000 acquisitions independent of how old any of the measurements are.

Gain

Gain processing accounts for the signal gain of the input amplifiers. The output is the product of the digitized value and the amplifier gain.

Zero Offset

Zero offset is active whenever the Offset annunciator is lit. The zero offset output is equal to the input value less the zero reference value.

Responsivity Map(s)

This process scales the input value in accordance with current calibration wavelength and the responsivity map downloaded from the detector calibration module. The output of this process, i.e. the measurement value, is the digitized input value divided by the responsivity associated with the current calibration wavelength or the user defined calibration value. Different responsivities are used depending upon if the attenuator is on as shown in the Setup Menu.

Units Correction

Unit's correction adjusts a measurement value to account for the display units selected. When the display units are equal to the detector signal units, i.e. equal to the numerator of the responsivity units, Table 1, the measurement value is not adjusted. Otherwise the digitized value is adjusted to account for detector responsivity and/or additional unit conversions such as W-to-W/cm².

NOTE

Per area unit conversions such as W-to-W/cm² divide the measurement value by the active area of the detector. This calculation assumes that the entire active area of the detector is uniformly illuminated. Per area measurements where the entire detector active area is not uniformly lit are not accurate. The user must insure that these conditions are met before utilizing per area units or make measurement corrections accordingly.

9.4 Typical Detector Signals

The flexibility of the Model 1935/2935 Series analog signal flow is required in order that it may properly measure the signals that various types of detectors make.

Basic optical power or energy measurements are related to a measured detector signal, S , in the following way:

$$P \text{ or } E = \frac{S}{R_{\lambda}}$$

Where: R_{λ} = Detector responsivity at λ
 S = Detector signal

Semiconductor (918D/818 Series Low-Power) detectors provide a current signal. The 1935/2935 Series is capable of 7.63pA resolution in order to provide the highest sensitivity performance with these detectors.

Thermopile (818P Series High-Power) detectors, provide a small voltage signal.

The 1935/2935 is capable of 76.3nV resolution in order to reach the sensitivity limits of thermopile detectors.

Pyroelectric (818E Series Energy) detectors, deliver a peak voltage signal.

The 1935/2935 is capable of capturing 2 μ sec rise time voltage spikes so that it may be operated with the fastest of these detectors.

9.5 Thermopile Detector Signals

Thermopile detectors respond with a voltage signal that slowly changes in incident optical power. The time constant of most thermopile detectors is on the order of 1 to 10 seconds.

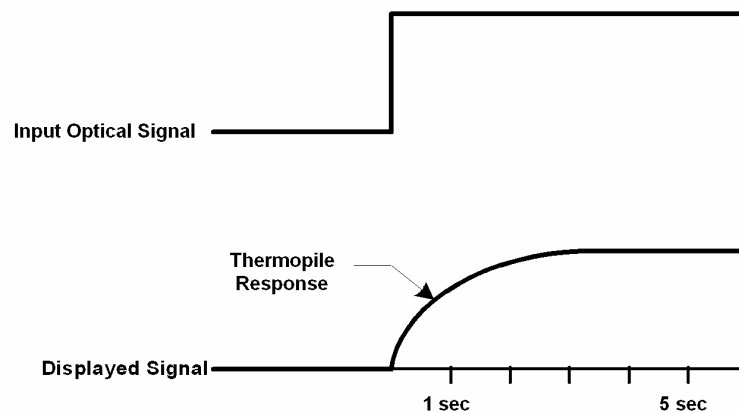

Figure 66 Thermopile Signals exhibit 1 to 10 second time constants.

9.6 Pulse Energy Detector Signals

A Newport Energy detector will respond to a single radiant energy pulse with a voltage pulse at its BNC output. This pulse exhibits a sharp voltage rise to a peak followed by a slower voltage decay that “undershoots” zero volts before settling back to zero volts. When a detector is operated within its proper limits, the voltage difference from immediately before the sharp rise to the peak is linearly proportional to the radiant energy.

If a second pulse arrives before the “undershoot” rises back to zero volts, the voltage rise from this pulse will start from an initial negative value. At sufficient energy pulse repetition rates, a negative “baseline” voltage will develop from which the voltage rise must now be measured to achieve accurate energy readings. The 1935/2935 Series contains baseline capture circuitry that maintains its accuracy specifications over rep-rates ranging from single pulse to 10 kHz.

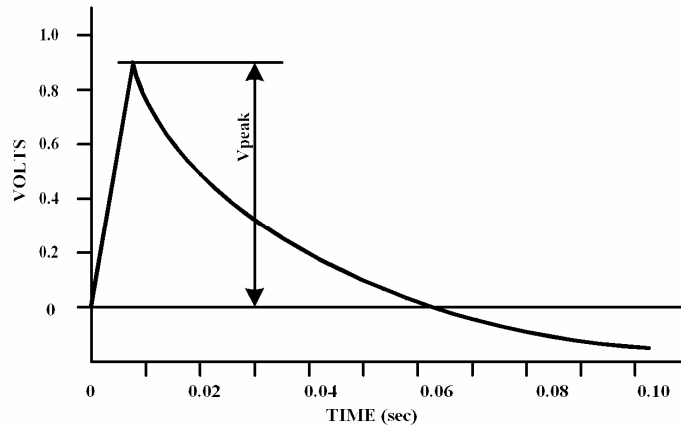

Figure 67 Typical Newport Energy Detector Signal Waveform
 An energy detector signal sharply rises to a peak value and then decays going somewhat negative before finally returning to zero. The energy in the radiant pulse is proportional to the height of the peak measured from immediately before the sharp rise.

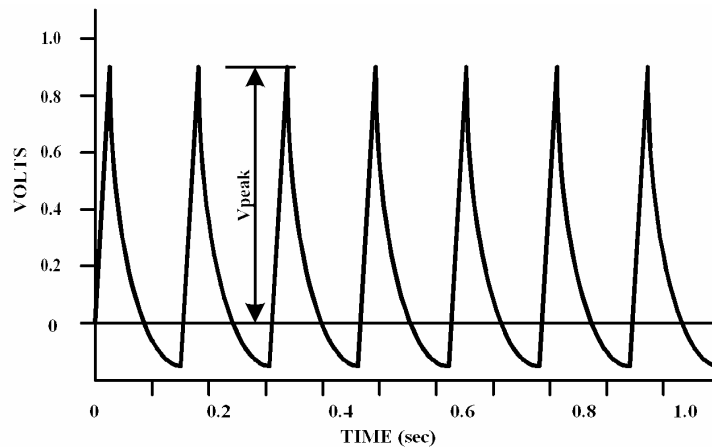

Figure 68 Negative Baseline Voltage.
 Negative Baseline Voltage Due to a Pulse Trainshown. If a laser pulse arrives before the previous Energy detector signal has fully decayed, the detector signal rises from the present decay point of the previous signal.

9.7 Peak-to-Peak (Photodiode) Detector Signals

The 1935/2935 Series allows one to make peak-to-peak measurements of time varying signals from semiconductor photodiode detectors. Since optical power is a zero bounded positive quantity, signals from a detector observing such modulated light will similarly be zero bounded positive signals. To make a peak-to-peak measurement, the 1935/2935 Series must be able to capture both the maximum and minimum values of a detector signal. This is accomplished by sampling.

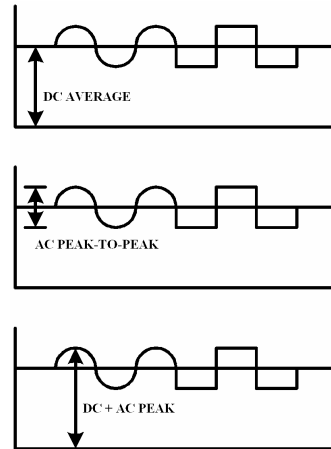

Figure 69 Time Varying Signal Measurements.

Many different measurements can be made on different portions of a time varying signal. The most common are: DC power, peak power, and peak-to-peak power.

9.8 Integration of Detector Signals

The 1935/2935 Series provides for making measurements that integrate incoming power detector signals to obtain an energy via the CW Integrate mode. In CW Integrate mode, the display units indicate Joules since energy is the time integral of power:

$$E(\lambda) = \int_{t_0}^{t_1} P(\lambda) dt = \int_{t_0}^{t_1} \frac{S(t)}{R(\lambda)} dt$$

As the detector signal actually consists of a stream of digitized values, the integral becomes a numerical approximation using the trapezoid method. See Figure 70.

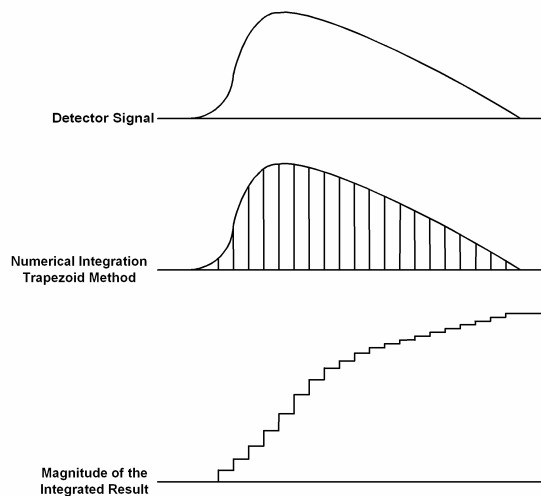

Figure 70 Integrated Energy Via a Trapezoid Approximation.

The INTG measurement mode performs a discrete integration at a 400 Hz sample rate.

Two common applications are natural extensions of the CW Integrate measurement mode:

1. Pulse laser energy measurement using a thermopile detector
2. Energy from exposure over a period of time (dosage)

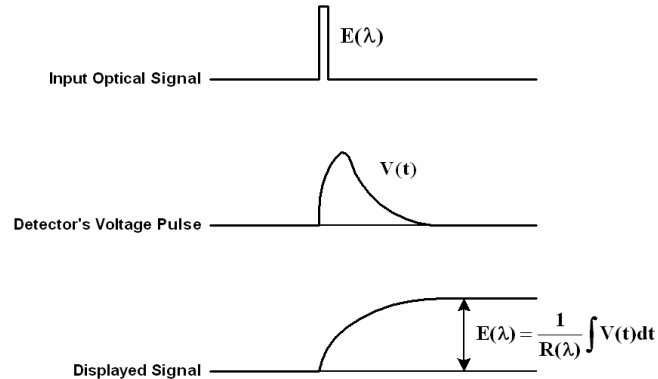

Figure 71 Measuring Laser Pulse Energy with a Thermopile. Thermopiles are often used to measure pulsed laser energy by integrating the response of the detector to the pulse.

9.9 Analog Output

The Model 1935/2935 Series provides an analog output for signal monitoring. The analog output is the actual amplified detector signal and is uncorrected for the effects of the detector's responsivity, calibration, and ZERO. The analog output signal is a representation of what the meter "sees" at its input. However, the analog output signal may be filtered if the user selects any cutoff frequency from the drop down menu of the analog filter (see paragraph 4.1.6). Also, the analog output signal is amplified and scaled to the selected analog output level (see Table 5).

The user can select the analog output level, also called Output Range, from the Setup menu. The analog output maximum level corresponds to the maximum full-scale input range the meter is set on. For example, if one selects the analog output level at 0.5 V into 50 Ω, and the meter is set on 250 mW maximum full-scale input range, the analog output signal will have a transfer function of 250 mW/0.5 V. Therefore, if the analog output BNC is connected to an oscilloscope or voltmeter with 50 Ω input impedance and the user reads 0.25V, the detector power is 125 mW.

The selectable analog output levels are given in Table 5.

Output Range	0	1	2	3
Full Scale Voltage (Load > 100 kΩ)	1V	2V	5V	10V
Full Scale Voltage (Load = 50 Ω)	0.5V	1V	2.5V	-

Table 5 Analog Output Range Table.

9.10 Measurement Considerations

This section describes detector characteristics, optical and electrical considerations, and environmental influences on optical measurements. In general, measurement accuracy is limited by the accuracy of the detector calibration.

Accurate measurements, however, are also dependent upon proper set-up, control of temperature and illumination conditions and understanding the factors that affect optical measurements.

9.10.1 Detector Calibration and Accuracy

Newport Corporation calibrates its detectors using secondary standards directly traceable to the United States National Institute of Science and Technology (NIST) or to Great Britain's National Physical Laboratory (NPL).

The details and accuracy of the calibration procedure vary with each detector model but a detailed description of the calibration results is supplied with each individually calibrated detector. In general, detector calibration accuracy varies from 2% to 5% in absolute terms and varies with wavelength. Each detector will also have some variation in response over its surface. Therefore, for the most reproducible measurements, light should illuminate the detector as uniformly as possible over as large an area as practical.

	<p>CAUTION</p> <p>Avoid focusing a light source onto the detector surface. Inaccurate readings and possible detector damage may result. Consult the detector manual for saturation or damage thresholds.</p>
---	--

NIST trace ability requires that detectors be recalibrated on one-year intervals. As individual detector responses change with time, especially in the ultraviolet, recalibration is necessary to assure confidence in the accuracy of the measurement. For the most reproducible measurements, the same detector should always be used for measurements that are to be directly compared.

9.10.2 Quantum Detector Temperature Effects

Semiconductor (Newport Low-Power) detectors are affected by temperature. At long wavelengths, quantum detectors typically lose sensitivity with increasing temperature. Additionally, detector dark current increases exponentially with temperature. Observed dark current is often dominated by the interaction between the detector and a meter's amplifier and is typically larger than the theoretical dark current limit. Silicon detectors are inherently quieter than germanium detectors due to their higher internal resistance and lower capacitance. The noise or drift in the dark current sets a lower bound

on the measurement resolution that can be achieved with any given detector. Cooling a detector significantly lowers its dark current and dark current noise.

The observed dark currents can also be zeroed at any moment via the ZERO function. Since dark currents drift with temperature, the ZERO should be adjusted just prior to taking any measurements. If the detector temperature is constant, sensitivity changes and dark current drifts are significantly reduced.

The 1935/2935 Series of optical power meters can measure the detector temperature and correct the power readings accordingly. The power correction happens automatically only for those detectors which are equipped with a thermistor (Newport offers detectors with thermistors for temperature compensation. See Newport web-site www.newport.com for more details.)

The thermistor signal is read via the detector DB-15 connector and the displayed power is adjusted continuously depending on the detector temperature. The analog output signal shows the detector signal and is not corrected for temperature.

For those detectors that can be cooled with a TEC element the 1935T-C and 2935T-C optical power meters have built in TEC controllers. The temperature is held automatically at a level dictated by the detector calibration module. Newport cooled detectors have two connectors. One is the DB-15 connector that is plugged at the power meter detector input (DET), CH A or CH B. The other connector is DB-9 and is plugged at the TEC A or TEC B connector.

9.10.3 Thermopile Detector Temperature Effects

Thermopile (Newport High-Power) detectors are significantly affected by temperature fluctuations arising from airflow disturbances. As the detector is a temperature-measuring device, airflow disturbances set a practical lower limit on the power that a detector can measure. In order to get the most out of any thermopile detector, be careful to shield the detector from airflow disturbances. Common sources of disturbance are: air conditioners and people walking past.

9.10.4 Energy Detector Temperature Effects

Pyroelectric (Newport Energy) detectors are AC coupled devices and thus are not susceptible to temperature induced DC signal offsets or noise floor changes.

One generally does not need to take much precaution with pyroelectric detectors except to make sure that their damage threshold is not exceeded.

9.10.5 Ambient and Stray Light

Ambient and stray light striking the detector should be considered when making a measurement. Ambient light can be distinguished from dark current (or the detector/meter noise floor) by either turning off or blocking the source

and covering the detector face with opaque material such as a piece of black rubber.

Using the human hand to cover the detector is not advised because it emits a significant amount of infrared radiation and radiates a temperature significantly different from ambient. With the detector covered, a reading of the dark current may be made. Next, remove the material that is covering the detector and take another reading. The difference is the ambient light level.

NOTE

Changes in ambient light levels can occur from such factors as turning room lights on or off, or by moving people or equipment. Remember, if you can see your detector element, then your detector can see the light bouncing off you.

The effects of ambient light are greatly reduced when using a fiber-connectorized signal input to the detector. If free-space beam measurements are desired, using an attenuator will often improve the signal to ambient signal noise level.

Wavelength-specific filters, such as optical cutoff, band pass, or spike filters can be used if the signal wavelength spectrum permits. Other techniques to reduce stray light include using apertures, placing the detector in a box or other housing to shield the surface from light (or air currents) and turning off room and other polluting light sources.

9.10.6 Signal Filtering

The 1935/2935 Series offer the user the option to filter the detector signal. There are two programmable filters that can be used individually or together to condition the detector signal: the Analog Filter and the Digital Filter.

The Analog Filter is a hardware based, programmable low-pass filter. The user can select the following settings: 5Hz, 1kHz, 12.5kHz, and 250kHz. This flexibility is offered to the user to improve the measurement precision for different detectors.

It is well known that white noise has large spectrum. The noise level increases with bandwidth. The higher the noise, the higher the minimum signal that can be measured. The quality of the measurement can be linked to the signal-to-noise ratio (SNR): the higher the SNR, the better the measurement precision of very small signals. In order to increase the SNR the user may choose to cut the bandwidth of the meter, depending on the detector signal.

For example, if the detector is modulated with a sine wave of 800Hz, the user may choose to set the Analog filter to 1kHz to increase the SNR and be able to measure very small signals. Also, cutting the bandwidth at 1kHz does not affect the measurement. However, if the modulation frequency is 800Hz, but the signal is a square, the user may opt to cut the bandwidth higher, at 12.5kHz, to let the signal harmonics be unfiltered and minimize the distortion. Of course, in this case, the noise in the system will increase with the square root of the bandwidth. The user needs to assess the tradeoffs in his

measurement, taking advantage of the 1935/2935 Series high flexibility in setting the proper filters for the measurement.

Generally, the 5Hz filter is used for CW Cont. measurements. However, the 1935/2935 Series can measure the amplitude of AC signals down to 0.01Hz, so the 5Hz filter can be used for any modulating signal below 5Hz.

The Digital Filter is a moving average filter that can be set at 10, 100, 1000, or 10000 measurements. These values can be changed by the user. If the digital filter is set on 10, the average value is computed on 10 measurements, in a First In First Out (FIFO) fashion. The Digital Filter helps the SNR the same way as the Analog Filter does. With both filters on, low level, continuous signals can be measured with a high degree of accuracy.

The Analog Filter is always applied to the entire amplifier chain of the meter. Therefore, the user will see the detector signal filtered at the Analog Output BNC. The Digital Filter is a digital signal-processing filter and is only applied to the calculated measured values that are displayed on the meter screen. While the displayed values may have both filters applied (An+Dg) the Analog Output can only have the Analog Filter applied to the signal. Because of that, the user may see a difference in the way the signal is filtered between the displayed values and the Analog Output values.

When the system performs frequency measurements the analog filter is ignored.

9.11 Common Measurement Errors

The most common sources of optical measurement error are listed in Table 6 below. Other common errors are discussed in the preceding subsections of Measurement Considerations.

Type of Error	What should be done?
Radiometry	Check that all of the light is actually hitting the detector
Ambient light	Check that any ambient light was ZEROed before the measurement was made.
Wavelength calibration	Check that the calibration factor for the measurement wavelength is properly set.
Detector saturation is damage	Check that the optical power density remains below the detector's saturation or damage

Table 6 Common Measurement Errors

This page is intentionally left blank

10 Maintenance and Service



CAUTION

There are no user serviceable parts inside the 1935/2935 Series Optical Power Meters. Work performed by persons not authorized by Newport Corporation will void the warranty.

Calibration accuracy is warranted for a period of 1 year. After 1 year, the unit should be returned to Newport Corporation for recalibration and NIST trace ability re-certification.

10.1 Enclosure Cleaning



WARNING

Before cleaning the enclosure of the 1935/2935 Series Optical Power Meters, the AC power cord must be disconnected from the wall socket.

The enclosure should only be cleaned with isopropyl alcohol or a mild soapy water solution applied to a damp lint-free cloth.

10.2 Fuse Replacement

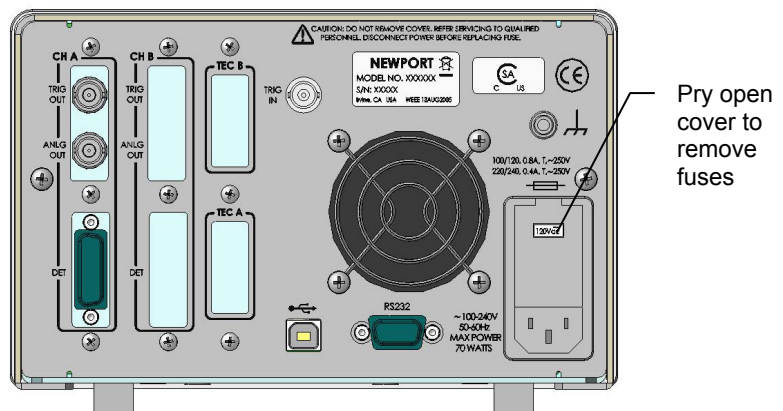

Figure 72 Fuse Replacement



WARNING

To reduce the risk of electric shock or damage to the instrument, turn the power switch off and disconnect the power cord before replacing a fuse.

If a fuse blows:

1. Disconnect the power cord from the instrument
2. Pry out the fuse cover and remove the fuse holders.
3. Replace the fuse(s).

Use only Slo-Blo fuses as indicated below

<u>Fuse Replacement</u>	<u>Line Voltage</u>
0.80Amp, (T), 250V	100/120VAC
0.40Amp, (T), 250V	220/240VAC

4. Reconnect the power cord and turn on the instrument.
5. If the problem persists, contact Newport Corporation for service.

10.3 Obtaining Service

Models 1935/2935 Series Optical Power Meters contain no user serviceable parts. To obtain information regarding factory service, contact Newport Corporation or your Newport representative. Please have the following information available:

1. Instrument model number (on the rear panel)
2. Instrument serial number (on rear panel)
3. Description of the problem.

If the instrument is to be returned to Newport Corporation, you will be given a Return Number, which you should reference in your shipping documents. Please fill out a copy of the service form, located on the following page, and have the information ready when contacting Newport Corporation. Return the completed service form with the instrument.

10.4 Service Form



Newport®
Experience | Solutions

Newport Corporation
U.S.A. Office: 800-222-6440
FAX: 949/253-1479

Name _____ **Return Authorization #** _____
(Please obtain RA# prior to return of item)

Company _____
(Please obtain RA # prior to return of item)

Address _____ Date _____

Country _____ Phone Number _____

P.O. Number _____ FAX Number _____

Item(s) Being Returned:

Model # _____ Serial # _____

Description _____

Reason for return of goods (please list any specific problems):

This page is intentionally left blank

11 Appendix A – Syntax and Definitions

11.1 Definition of <string>

For convenience, the 1935/2935 Series recognizes double quoted, single quoted, and unquoted strings with certain restrictions as detailed below. Any of these forms may be used where a <string> parameter is required.

1. <string>,using double quotes **“this is a string”**
2. <string>,using single quotes. **‘this is a string’**
3. <string>,using no quotes. **thisisastring**

A description of each type of <string> follows:

1. <string> defined using double quotes.

A double quote indicates that a string follows, and the string is terminated by another double quote. A double quote may be embedded within the string by using two double quotes together:

Example: “this string contains a “”double quote”

All characters within the two outer double quotes are considered part of the string. It is an error if the string does not terminate with a double quote. The string cannot contain the <CR>(ASCII decimal 13), <LF>(ASCII decimal 10), or End or Identify characters.

2. <string> defined using single quotes.

This form is similar to double quoted string. A single quote indicates that a string follows, and the string is terminated by another single quote. A single quote may be embedded within the string by using two single quotes together:

Example: ‘this string contains a’single quote’

All characters within the two outer single quotes are considered part of the string. It is an error if the string does not terminate with a single quote. The string cannot contain the <CR>(ASCII decimal 13), <LF>(ASCII decimal 10), or End or Identify characters.

3. <string> defined using no quotes.

All strings using this format must start with an alphabetic character (A through Z, a through z). All other characters must be either alphabetic, digit (0 through 9) or the ‘_’ character. Any other character will delimit the string.

Some examples are shown below:

Sent:	this is a string	
Interpreted:	this	(1st string)
	is	(2nd string)
	a	(3rd string)
	string	(4th string)
Sent:	this,isastring	
Interpreted:	this	(1st string)
	,	(separator character)
	isastring	(2nd string)
Sent:	w/cm	
Interpreted:	w	(1st string)
	ERROR	(unrecognized character)
	cm	(2nd string)

11.2 Definition of <number>

1935/2935 Series recognizes four types as <number> ,thus any format may be used.

4. 1. <number> defined as floating point.
5. 2. <number> defined as binary.
6. 3. <number> defined as octal.
7. 4. <number> defined as hexadecimal.

Where necessary, integers are converted to floating point numbers. In all cases, a number is terminated by any of the below characters:

<NL> <EOI> <SPACE>

Any non-valid characters detected in any number received are considered an error in format, and an error condition will be generated in the system.

A description of each type of <number> follows:

1. <number> defined as floating point.

Any of the following characters, as the first character of an ASCII sequence, indicates that a number is being defined:

+-.0 1 2 3 4 5 6 7 8 9

A floating point number is defined as follows:

1. Optional +-sign. This defines the sign of the number. If missing, positive is assumed.
2. Optional 0-9 digits. These digits define the integer portion of the mantissa.
3. Optional . decimal point. This defines the end of the integer portion of the mantissa, and indicates that the fractional portion of the mantissa follows.
4. Optional 0 -9 digits. These digits define the fractional portion of the mantissa.
5. Optional exponent indicator, an ASCII 'E' or 'e', followed by a '+' or '-' (optional), followed by decimal digits.

Examples:

The numbers below all represent the value "1.2 "

1.2
1.2e0
+01.2E+00000
120E-2
.12e1

The numbers below all represent the value "-1.2 "

-1.2
-1.2e+00
-0001.2e+0
-120e-2
.12E1

2. <number>defined as binary.

The 1935/2935 Series recognizes unsigned binary numbers in the range of 0 to 65535, decimal, or 0 to 1111111111111111 binary. Binary numbers are represented using only the digits 0 and 1.A binary number has the following format:

#B<*binary*>

Where

#B = mandatory binary number header

<*binary*> = binary digits (0's or 1's)

Example:

All numbers below represent the decimal value 129.

#B10000001

#b010000001

#b10000001

3. *<number>* defined as octal.

The 1935/2935 Series recognizes unsigned octal numbers in the range 0 to 65535 decimal, or 0 to 177777 octal. Octal numbers are represented using digits from 0 to 7. An octal number has the following format:

#Q*<octal>*

Where

#Q = mandatory octal number header

<octal> = octal digits (0 to 7)

Example:

All numbers below represent the decimal value 129.

#Q201

#q0201

#q201

4. *<number>* defined as hexadecimal.

The 1935/2935 Series recognizes unsigned hexadecimal numbers in the range 0 to 65535 decimal, or 0 to FFFF hexadecimal. Hexadecimal numbers are represented using the digits 0 -9 and the characters A -F. A hexadecimal number has the following format:

#H*<hexadecimal>*

Where

#H = mandatory octal number header

<hexadecimal> = hexadecimal digits (0 -9 and A -F)

Example:

All numbers below represent the decimal value 127.

#H7f

#H007F

#h7f

12 Appendix B – Error Messages

12.1 Introduction

When using the RS-232 port the RS-232 Echo Mode controls when errors are returned. When the Echo Mode is enabled the errors are returned immediately. When the Echo Mode is disabled the errors are not returned immediately and the *ERR? or ERRSTR? commands must be used to retrieve the errors.

12.2 Command Errors

Command Errors are associated with the conversion of the data received into the commands and their parameters (parsing). Incorrect syntax, incorrect parameters, and improper command format will generate these errors. Any command error will cause the Command Error bit (bit 5) in the Standard Event Status Byte to be set.

104, Numeric Type Not Defined

Generated during the parsing of a number and an undefined number type is encountered.

106, Digit Expected

Generated during the parsing of a number and the parser encounters a non-number when a number is expected.

107, Digit Not Expected

Generated during the parsing of a number and the parser encounters a number when a different character is expected.

115, Identifier Not Valid

Generated when a parameter is not valid or not properly formed.

116, Syntax Error

Occurs when an error in command structure or parameter type is detected. Some typical causes are:

- Using a number as a command mnemonic.
- Using the wrong parameter type.
- Using ASCII characters outside of a string constant that are not defined by the command language syntax.

- Missing or too many parameters.

The above list is not exhaustive but does give the basic idea of what to look for.

126, Too Many Or Few Arguments

Generated when command arguments are missing or too many.

12.3 Execution Errors

Execution Errors are associated with the interpretation of the converted commands and parameters received. Incorrect parameter values and numerical range errors are types of execution errors. Any execution error will cause the Execution Error bit (bit 4) in the Standard Event Status Byte to be set.

1, Out of memory

This error is caused by an internal program fault, and may be followed by an automatic instrument reset.

201, Value Out Of Range

This error will occur if a parameter is out of a valid range or not in the set of valid parameters for a given command.

214, Exceeds Maximum Length

Generated when the command exceeds the maximum command length. Try shortening the command string.

217, No saved information in recalled bin

Generated when the user attempts to recall a bin which has no previous stored data.

301, Query Error

The Query Error occurs when the instrument is in the midst of transmitting a message over a communication bus and the instrument exits remote mode.

303, Input Buffer Overflow

Error generated when the system parser runs out of space during reception of command. It may occur if commands are not terminated correctly. Input buffer is 1,024 characters long.

304, Output Buffer Overflow

Error generated when the system parser runs out of space for query results. It may occur if query results in too much data to be returned in a single response, or if multiple command queries are issued but not read. Output buffer is 4,096 characters long.

305, Parser Buffer Overflow

Error generated when the system parser runs out of space for commands. A command is received into the input buffer then transferred to the parser buffer.

This error is generated if the command in the input buffer is too large to fit into the available space in the parser buffer. It is usually generated when commands are sent to the instrument faster than it can process. Parser buffer is 2,048 characters long.

12.4 Device Errors

Device Errors are associated with some system condition that affects the operation of the meter. Errors associated with data reading will set the appropriate bit but will not generate an error message to avoid jamming the error queue or the interface.

701, Detector Calibration Read or Write Failed.

An error was encountered during a read/write operation to the calibration EPROM in the detector. If problem persists, contact the factory.

703, Power Meter set to defaults due to Firmware update

After upgrading the firmware, in some cases the changes are significant enough to require resetting the instrument to factory defaults.

704, User reference cannot be changed/stored while you are in units of Watts or dBm. Change to dB or Rel to set the user reference value.

User reference can only be stored in dB or Rel mode.

705, Illegal data store parameter change. Queue cleared.

An action that affects the data store caused the data store queue to be cleared.

706, Digital Filter Interval changed, must not be greater than Data Store interval.

The digital filter interval cannot be greater than the data store interval.

707, Digital Filter Disabled with External Trigger.

Digital filter must be disabled during external trigger mode.

708, There is no new data for a statistics update.

No new data has been stored in the data store since the last statistics update.

709, Statistics are not calculated while Data Store is running.

User attempted to compute statistics while data store was active. Turn off data store and compute.

This page is intentionally left blank

13 Appendix C - Legacy Commands Reference

Name	Number of Parameters	Function	Legacy Commands
DISP:BRIGhT	1	Sets the backlight level of the display and the keypad	
DISP:BRIGhT?	NONE	Returns the backlight level of the display and the keypad	
DISP:SCReen	1	Switches to the n - screen display.	
DISP:SCReen?	NONE	Returns displayed screen number, 0 – n/a screen number, 1 – Main, etc.	
PM:ANALOG:OUT	1	Sets the analog output range to the desired level	
PM:ANALOG:OUT?	NONE	Returns the analog output range	
PM:ATT	1	Selects if the attenuator's calibration data is included for power calculation.	ATTN_n
PM:ATT?	NONE	Returns setting if attenuator data should or should not be used when calibrating the power meter.	ATTN_n?
PM:ATTsN?	NONE	Gets the attenuator serial number.	ATTNSN_n?
PM:AUTO	1	Sets the power meter ranging to manual or automatic.	AUTO_n
PM:AUTO?	NONE	Returns 1 if automatic power meter ranging is selected.	AUTO_n?
PM:CALDATE?	NONE	Returns the calibration date of the detector.	CALDATE_n?
PM:CALTEMP?	NONE	Returns the temperature at which the calibration was performed.	CALTEMP_n?
PM:CHANnel	1	Selects the power meter channel to display and control.	
PM:CHANnel?	NONE	Returns the power meter channel currently selected.	
PM:DETMODEL?	NONE	Returns the model number of the detector.	DETMODEL_n?
PM:DETSN?	NONE	Returns the serial number of the detector.	DETSN_n?
PM:DS:BUfFer	1	Set data store behavior select.	DSBUF_n
PM:DS:BUfFer?	NONE	Return data store behavior select.	DSBUF_n?
PM:DS:CLear	NONE	Clear data store.	DSCLR_n
PM:DS:Count?	NONE	Return data store count of items stored.	DSCNT_n?
PM:DS:ENable	1	Set data store enable.	DSE_n
PM:DS:ENable?	NONE	Return data store enable.	DSE_n?
PM:DS:GET?	1	Return data store data. {1,1-10,-5,+5} – value, range, oldest 5, newest 5	DS_n?
PM:DS:SIZE	1	Sets the size of the Data Store buffer	
PM:DS:SIZE?	NONE	Return the sizes of the Data Store buffer	
PM:DS:INTerval	1	Set data store interval.	SFREQ
PM:DS:INTerval?	NONE	Return data store interval.	SFREQ?
PM:DS:SAVEBUFER	1	Saves the data store buffer to USB flash disk	
PM:DS:SIZE	1	Set data store max size.	DSSIZE_n
PM:DS:SIZE?	NONE	Return data store max size.	DSSIZE_n?
PM:DS:UNITs?	NONE	Return data store units.	DSUNITS_n?
PM:FILTer	1	Selects the filtering operation: no filtering, analog filter, digital filter, or analog and digital.	FILTER_n
PM:FILTer?	NONE	Returns the filtering operation: no filtering, analog filter, digital filter, or analog and digital.	FILTER_n?
PM:Lambda	1	Sets the wavelength for use when calculating power.	LAMBDA_n
PM:Lambda?	NONE	Gets the selected wavelength in nanometers.	LAMBDA_n?

Name	Number of Parameters	Function	Legacy Commands
PM:MAX:Lambda?	NONE	Returns the longest calibrated wavelength in nanometers.	
PM:MAX:Power?	NONE	Returns current range's maximum readable power.	
PM:MIN:Lambda?	NONE	Returns the shortest calibrated wavelength in nanometers.	
PM:MODE	1		MODE_n
PM:MODE?	NONE	Returns the currently selected acquisition mode.	MODE_n?
PM:Power?	NONE	Returns the power in the selected units.	R_n?
PM:PWS?	NONE	Returns the power with status.	RWS_n?
PM:RANge	1	Selects the gain stage when making readings with the detector head within a range from 0 to 5 (with zero being the highest).	RANGE_n
PM:RANge?	NONE	Returns an integer indicating the current range.	RANGE_n?
PM:RESPOnsivity?	NONE	Gets the responsivity currently used for making power calculations.	RESP_n?
PM:RUN	1	Disables or enables the acquisition of data.	RUN_n, STOP_n
PM:RUN?	NONE	Returns the present acquisition mode.	RUN_n?, STOP_n
PM:STAT:MAX?	NONE	Return statistics buffer maximum value.	STMAX_n?
PM:STAT:MEAN?	NONE	Return statistics buffer mean value.	STMEAN_n?
PM:STAT:MIN?	NONE	Return statistics buffer minimum value.	STMIN_n?
PM:STAT:MAXMIN?	NONE	Return statistics buffer maximum-minimum value.	STMXMN_n?
PM:STAT:SDEVIation?	NONE	Return statistics buffer standard deviation value.	STSDEV_n?
PM:Temp?	NONE	Returns the 918 detector's temperature in degrees Celsius.	
PM:TRIG:EXTErnal	1	Set external trigger enable.	EXT
PM:TRIG:EXTErnal?	NONE	Return external trigger enable.	EXT?
PM:TRIG:EDGE	1	Set external trigger edge select.	EXTEDGE
PM:TRIG:EDGE?	NONE	Return external trigger edge select.	EXTEDGE
PM:TRIG:HOLDoff	1	Set external trigger holdoff time.	EXTHOLDOFF
PM:TRIG:HOLDoff?	NONE	Return external trigger holdoff time.	EXTHOLDOFF?
PM:UNITs	1	Selects the units for readings.	UNITS_n
PM:UNITs?	NONE	Returns an integer indicating the selected units.	UNITS_n?
PM:REF:VALue	1	Sets the user reference value for use in relative or dB readings.	USRREF_n
PM:REF:VALue?	NONE	Returns the user reference value.	USRREF_n?
PM:REF:STOre	NONE	Sets the user reference value for use in relative or dB readings as the present reading.	STOREF_n
PM:ZEROStOre	NONE	Sets the zeroing value with the present reading.	STOZERO_n
PM:ZEROVALue	1	Sets the zeroing value.	ZEROVAL_n
PM:ZEROVALue?	NONE	Gets the zeroing value.	ZEROVAL_n?
TEC:T?	NONE	Return TEC measured temperature.	

Table 7 Legacy Commands Reference

14 Appendix D – Sample Programs

14.1 Programming Samples

The CD will install some simple programming samples to get computer interfacing started. These are minimal samples and provided only for reference.

14.2 LabVIEW

LabVIEW programming samples separated in folders based on version of LabVIEW compiled with. SampleQuery.vi demonstrates the use of the drivers.

14.3 Microsoft® Visual Basic

A zip file in the application folder contains a simple Visual Basic project for communicating with the meter.

14.4 Microsoft Visual C++

A zip file in the application folder contains a simple Visual C++ project for communicating with the meter.

14.5 Microsoft .NET

A zip file in the application folder contains a simple .NET project for communicating with the meter.

This page is intentionally left blank

15 Appendix E – Disassembly Instructions

NOTE

These disassembly instructions are intended only for recycling at the end of the product lifetime.

For troubleshooting or servicing, users should contact the local Newport Corporation representative. There are no user serviceable parts inside the equipment. Attempting to self-service the unit will void the warranty.

15.1 Disassembly instructions

Figure 73 shows an exploded version of the 1935/2935 Series.

For recycling purposes, only, the disassembly steps are as follows:

1. Make sure the unit power cord is removed.
2. Remove any other cables: detectors, trigger cables, Analog Output monitor cables, USB, RS232, TEC cables, ground cable.
3. Remove the bottom screws of the cover.
4. Remove the cover.
5. Remove all the screws on the rear panel, except the fan screws.
6. Remove the rear panel.
7. Unplug PCBA 1, 2 and 3 from the front panel.
8. Remove the screws that secure the front panel on enclosure.
9. Remove the front panel.
10. Remove the screws that secure PCBA 4 to the front panel.
11. Remove PCBA 4.
12. Remove the screws that secure PCBA 5 to the bottom of the enclosure.
13. Remove PCBA 5.

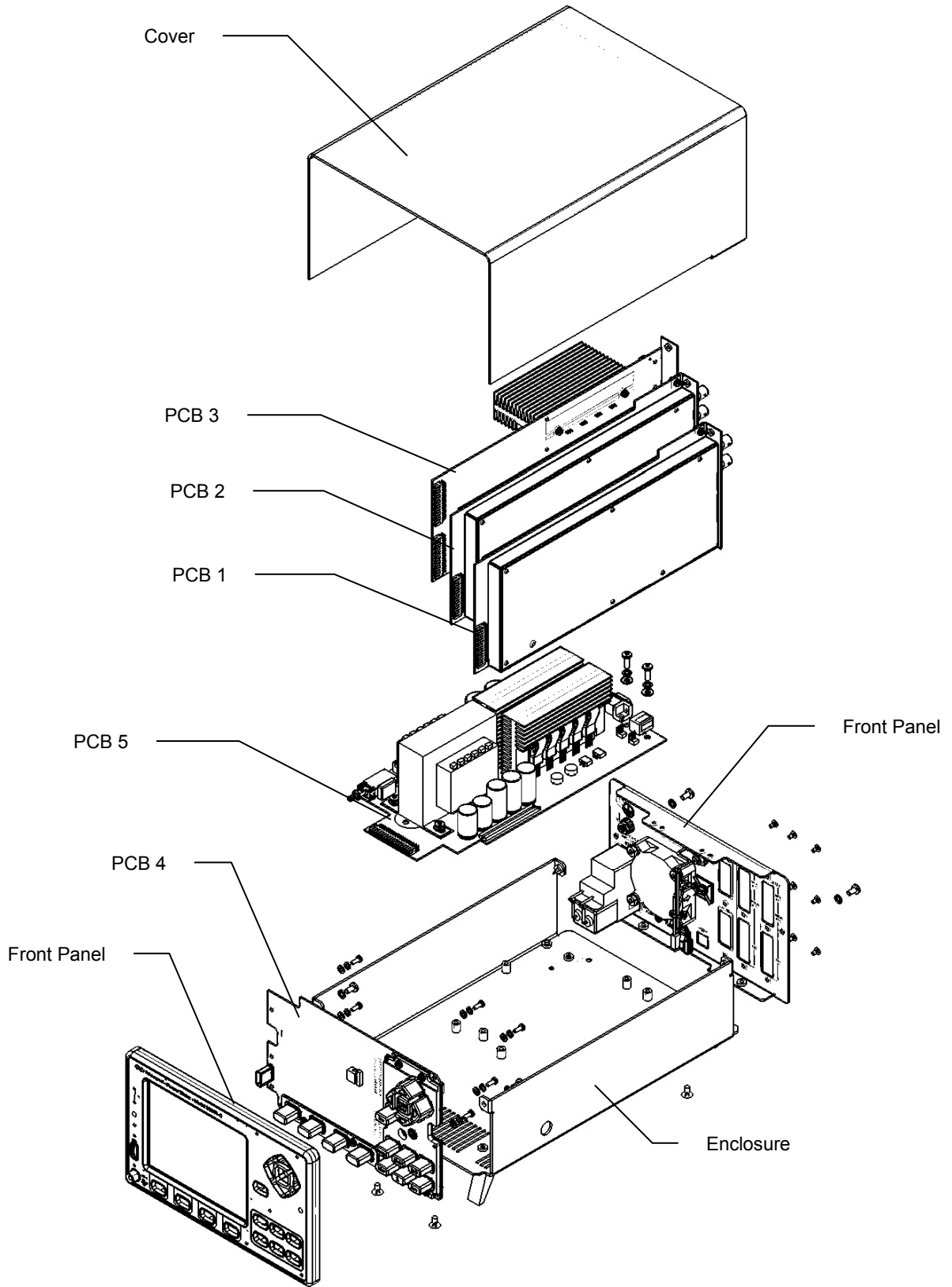

Figure 73 Disassembled 1935/2935 model

End User License Agreement for Embedded Software Components

You have acquired a device (“DEVICE”) that includes software licensed by Newport Corporation (“Newport”) from an affiliate of Microsoft Corporation (“MS”). Those installed software products of MS origin, as well as associated media, printed materials, and “online” or electronic documentation (“SOFTWARE”) are protected by international intellectual property laws and treaties. Manufacturer, MS and its suppliers (including Microsoft Corporation) own the title, copyright, and other intellectual property rights in the SOFTWARE. The SOFTWARE is licensed, not sold. All rights reserved.

This End User License Agreement (“EULA”) is valid and grants the end-user rights ONLY if the SOFTWARE is genuine Certificate of Authenticity for the SOFTWARE is included. For more information on identifying whether your software is genuine, please see <http://www.microsoft.com/piracy/howtotell>.

IF YOU DO NOT AGREE TO THIS EULA, DO NOT USE THE DEVICE OR COPY THE SOFTWARE. INSTEAD, PROMPTLY CONTACT NEWPORT FOR INSTRUCTIONS ON RETURN OF THE UNUSED DEVICES(S) FOR A REFUND. ANY USE OF THE SOFTWARE, INCLUDING BUT NOT LIMITED TO USE ON THE DEVICE, WILL CONSTITUTE YOUR AGREEMENT TO THIS EULA (OR RATIFICATION OF ANY PREVIOUS CONSENT).

GRANT OF SOFTWARE LICENSE. This EULA grants you the following license:

- You may use the SOFTWARE only on the DEVICE.
- **Restricted Functionality.** You are licensed to use the SOFTWARE to provide only the limited functionality (specific tasks or processes) for which the DEVICE has been designed and marketed by Newport. This license specifically prohibits any other use of the software programs or functions, or inclusion of additional software programs or functions that do not directly support the limited functionality on the DEVICE. Notwithstanding the foregoing, you may install or enable on a DEVICE, systems utilities, resource management or similar software solely for the purpose of administration, performance enhancement and/or preventive maintenance of the DEVICE.
- If you use the DEVICE to access or utilize the services or functionality of Microsoft Windows Server products (such as Microsoft Windows Server 2003), or use the DEVICE to permit workstation or computing devices to access or utilize the services or functionality of Microsoft Windows Server products, you may be required to obtain a Client Access License for the DEVICE and/or each such workstation or computing device. Please refer to the end user license agreement for your Microsoft Window Server product for additional information.
- **NOT FAULT TOLERANT.** THE SOFTWARE IS NOT FAULT TOLERANT. NEWPORT HAS INDEPENDENTLY DETERMINED HOW TO USE THE SOFTWARE IN THE DEVICE, AND MS HAS RELIED UPON NEWPORT TO CONDUCT SUFFICIENT TESTING TO DETERMINE THAT THE SOFTWARE IS SUITABLE FOR SUCH USE.
- **NO WARRANTIES FOR THE SOFTWARE.** The SOFTWARE is provided “AS IS” and with all faults. THE ENTIRE RISK AS TO SATISFACTORY QUALITY, PERFORMANCE, ACCURACY, AND EFFORT (INCLUDING LACK OF NEGLIGENCE) IS WITH YOU. ALSO, THERE IS NO WARRANTY AGAINST INTERFERENCE WITH YOUR ENJOYMENT OF THE SOFTWARE OR AGAINST INFRINGEMENT. **IF YOU HAVE RECEIVED ANY WARRANTIES REGARDING THE DEVICE OR THE SOFTWARE, THOSE WARRANTIES DO NOT ORIGINATE FROM, AND ARE NOT BINDING ON, MS.**
- **No Liability for Certain Damages.** EXCEPT AS PROHIBITED BY LAW, MS SHALL HAVE NO LIABILITY FOR ANY INDIRECT, SPECIAL, CONSEQUENTIAL OR INCIDENTAL DAMAGES ARISING FROM OR IN CONNECTION WITH THE USE OR PERFORMANCE OF THE SOFTWARE. THIS LIMITATION SHALL APPLY EVEN IF ANY REMEDY FAILS OF ITS ESSENTIAL PURPOSE. IN NO EVENT SHALL MS BE LIABLE FOR ANY AMOUNT IN EXCESS OF U.S. TWO HUNDRED FIFTY DOLLARS (U.S. \$250.00).
- **Restricted Uses.** The SOFTWARE is not designed or intended for use or resale in hazardous environments requiring fail-safe performance, such as in the operation of nuclear facilities, aircraft navigation or communication systems, air traffic control, or other devices or systems in which a malfunction of the SOFTWARE would result in foreseeable risk of injury or death to the operator of the device or system, or to others.
- **Limitations on Reverse Engineering, Decompilation, and Disassembly.** You may not reverse engineer, decompile, or disassemble the SOFTWARE, except and only to the extent that such activity is expressly permitted by applicable law notwithstanding this limitation.
- **SOFTWARE as a Component of the DEVICE – transfer.** This license may not be shared, transferred to or used concurrently on different computers. The SOFTWARE is licensed with the DEVICE as a single integrated product and may only be used with the DEVICE. If the SOFTWARE is not accompanied by a DEVICE, you may not use the SOFTWARE. You may permanently transfer all of your rights under this EULA only as part of a permanent sale or transfer of the DEVICE, provided you retain no copies of the SOFTWARE. If the SOFTWARE is an upgrade, any transfer must also include all prior versions of the SOFTWARE. This transfer must also include the Certificate of Authenticity label. The transfer may not be an indirect transfer, such as a consignment. Prior to the transfer, the end user receiving the SOFTWARE must agree to all the EULA terms.
- **Consent to Use of Data.** You agree that MS, Microsoft Corporation and their affiliates may collect and use technical information gathered in any manner as part of product support services related to the SOFTWARE. MS, Microsoft Corporation and their affiliates may use this information solely to improve their products or to provide customized services or technologies to you. MS, Microsoft Corporation and their affiliates may disclose this information to others, but not in a form that personally identifies you.
- **Links to Third Party Sites.** You may link to third party sites through the use of the SOFTWARE. The third party sites are not under the control of MS or Microsoft Corporation, and MS or Microsoft are not responsible for the contents if any third party sites, any links contained in third party sites, or any changes or updates to third party sites. MS or Microsoft Corporation is not responsible for webcasting or any other form of transmission received from any third party sites. MS or Microsoft Corporation are providing these links to third party sites to you only as a convenience, and the inclusion of any link does not imply an endorsement by MS or Microsoft Corporation of the third party site.

- **Notice Regarding Security.** To help protect against breaches of security and malicious software, periodically back up your data and system information, use security features such as firewalls, and install and use security updates.
- **No Rental/Commercial Hosting.** You may not rent, lease, lend or provide commercial hosting services with the SOFTWARE to others.
- **Separation of Components.** The SOFTWARE is licensed as a single product. Its component parts may not be separated for use on more than one computer.
- **Additional Software/Services.** This EULA applies to updates, supplements, add-on components, product support services, or Internet-based services components (“Supplemental Components”), of the SOFTWARE that you may obtain from Newport, MS, Microsoft Corporation or their subsidiaries after the date you obtain your initial copy of the SOFTWARE, unless you accept updated terms or another agreement governs. If other terms are not provided along with such Supplemental Components and the Supplemental Components are provided to you by MS, Microsoft Corporation or their subsidiaries then you will be licensed by such entity under the same terms and conditions of this EULA, except that (i) MS, Microsoft Corporation or their subsidiaries providing the Supplemental Components will be the licensor with respect to such Supplemental Components in lieu of Newport for the purposes of the EULA, and (ii) TO THE MAXIMUM EXTENT PERMITTED BY APPLICABLE LAW, THE SUPPLEMENTAL COMPONENTS AND ANY (IF ANY) SUPPORT SERVICES RELATED TO THE SUPPLEMENTAL COMPONENTS ARE PROVIDED AS IS AND WITH ALL FAULTS. ALL OTHER DISCLAIMERS, LIMITATION OF DAMAGES, AND SPECIAL PROVISIONS PROVIDED BELOW AND/OR OTHERWISE WITH THE SOFTWARE SHALL APPLY TO SUCH SUPPLEMENTAL COMPONENTS. MS, Microsoft Corporation or their subsidiaries reserve the right to discontinue any Internet-based services provided to you or made available to you through the use of the SOFTWARE.
- **Recovery Media.** If SOFTWARE is provided by Newport on separate media and labeled “Recovery Media” you may use the Recovery Media solely to restore or reinstall the SOFTWARE originally installed on the DEVICE.
- **Backup Copy.** You may make one (1) backup copy of the SOFTWARE. You may use this backup copy solely for your archival purposes and to reinstall the SOFTWARE on the DEVICE. Except as expressly provided in this EULA or by local law, you may not otherwise make copies of the SOFTWARE, including the printed materials accompanying the SOFTWARE. You may not loan, rent, lend or otherwise transfer the backup copy to another user.
- **End User Proof of License.** If you acquired the SOFTWARE on a DEVICE, or on a compact disc or other media, a genuine Microsoft “Proof of License”/Certificate of Authenticity label with a genuine copy of the SOFTWARE identifies a licensed copy of the SOFTWARE. To be valid, the label must be affixed to the DEVICE, or appear on Newport’s software packaging. If you receive the label separately other than from Newport, it is invalid. You should keep the label on the DEVICE or packaging to prove that you are licensed to use the SOFTWARE.
- **Product Support.** Product support for the SOFTWARE is not provided by MS, Microsoft Corporation, or their affiliates or subsidiaries. For product support, please refer to the Newport support number provided in the documentation for the DEVICE. Should you have any questions concerning this EULA, or if you desire to contact Newport for any other reason, please refer to the address provided in the documentation for the DEVICE.
- **Termination.** Without prejudice to any other rights, Newport may terminate this EULA if you fail to comply with the terms and conditions of this EULA. In such event, you must destroy all copies of the SOFTWARE and all of its component parts.
- **Export Restrictions.** You acknowledge that SOFTWARE is subject to U.S. and European Union export jurisdiction. You agree to comply with all applicable international and national laws that apply to the SOFTWARE, including the U.S. Export Administration Regulations, as well as end-user, end-use and destination restrictions issued by U.S. and other governments. For additional information, see <http://www.microsoft.com/exporting/>.

**Newport Corporation
Worldwide Headquarters**

1791 Deere Avenue
Irvine, CA 92606

(In U.S.): 800-222-6440
Tel: 949-863-3144
Fax: 949-253-1680

Internet: sales@newport.com



Newport®

Experience | Solutions

Visit Newport Online at: www.newport.com